

User Manual



TDS 200-Series Digital Real-Time Oscilloscope 071-0398-02

This document supports firmware version
FV:v1.00 and above.

www.tektronix.com

Copyright © Tektronix, Inc. All rights reserved.

Tektronix products are covered by U.S. and foreign patents, issued and pending. Information in this publication supercedes that in all previously published material. Specifications and price change privileges reserved.

Tektronix, Inc., P.O. Box 500, Beaverton, OR 97077

TEKTRONIX and TEK are registered trademarks of Tektronix, Inc.

WARRANTY SUMMARY
(TDS 200-Series Digitizing Oscilloscope)

Tektronix warrants that the products that it manufactures and sells will be free from defects in materials and workmanship for a period of three (3) years from the date of shipment from an authorized Tektronix distributor. If a product or CRT proves defective within the respective period, Tektronix will provide repair or replacement as described in the complete warranty statement.

To arrange for service or obtain a copy of the complete warranty statement, please contact your nearest Tektronix sales and service office.

EXCEPT AS PROVIDED IN THIS SUMMARY OR THE APPLICABLE WARRANTY STATEMENT, TEKTRONIX MAKES NO WARRANTY OF ANY KIND, EXPRESS OR IMPLIED, INCLUDING WITHOUT LIMITATION THE IMPLIED WARRANTIES OF MERCHANTABILITY AND FITNESS FOR A PARTICULAR PURPOSE. IN NO EVENT SHALL TEKTRONIX BE LIABLE FOR INDIRECT, SPECIAL OR CONSEQUENTIAL DAMAGES.

**WARRANTY SUMMARY
(P2100 Probe)**

Tektronix warrants that the products that it manufactures and sells will be free from defects in materials and workmanship for a period of one (1) year from the date of shipment. If a product proves defective within the respective period, Tektronix will provide repair or replacement as described in the complete warranty statement.

To arrange for service or obtain a copy of the complete warranty statement, please contact your nearest Tektronix sales and service office.

EXCEPT AS PROVIDED IN THIS SUMMARY OR THE APPLICABLE WARRANTY STATEMENT, TEKTRONIX MAKES NO WARRANTY OF ANY KIND, EXPRESS OR IMPLIED, INCLUDING WITHOUT LIMITATION THE IMPLIED WARRANTIES OF MERCHANTABILITY AND FITNESS FOR A PARTICULAR PURPOSE. IN NO EVENT SHALL TEKTRONIX BE LIABLE FOR INDIRECT, SPECIAL OR CONSEQUENTIAL DAMAGES.

Table of Contents

General Safety Summary	v
Contacting Tektronix	vii
Getting Started	1
General Features	2
Installation	3
Power Cord	3
Security Loop	3
Extension Modules	4
Functional Check	5
Probe Compensation	6
Self Calibration	7
Probe Safety	7
Probe Attenuation Setting	8
Basic Concepts	9
Triggering	10
Source	10
Types	11
Modes	11
Holdoff	13
Coupling	14
Position	14
Slope and Level	14
Acquiring Data	15
Acquisition Modes	15
Time Base	16
Scaling and Positioning Waveforms	16
Vertical Scale and Position	17
Horizontal Scale and Position; Pretrigger Information	17
Taking Measurements	20
Graticule	20
Cursors	21
Automated	21
Setting Up the Oscilloscope	21
Using Autoset	22
Saving a Setup	22
Recalling a Setup	22
Defaults (Factory Setup)	22

Operating Basics	23
Display Area	24
Using the Menu System	26
Circular List Menu Boxes	26
Action Button Menu Boxes	27
Radio Button Menu Boxes	27
Page Selection Menu Boxes	27
Waveform Displays	28
Vertical Controls	29
Horizontal Controls	31
Trigger Controls	32
Menu and Control Buttons	33
Connectors	35
Application Examples	37
Taking Simple Measurements	38
Using Autoset	38
Taking Automatic Measurements	39
Measuring Two Signals	40
Taking Cursor Measurements	42
Measuring Pulse Width	42
Measuring Rise Time	43
Measuring Ring Frequency	45
Measuring Ring Amplitude	46
Analyzing Signal Detail	47
Looking at a Noisy Signal	47
Separating the Signal from Noise	48
Capturing a Single-Shot Signal	49
Optimizing the Acquisition	50
Measuring Propagation Delay	51
Triggering on a Video Signal	53
Triggering on Video Fields	54
Triggering on Video Lines	54
Using the Window Function to See Waveform Details	55
Triggering on Odd or Even Video Fields	57
Analyzing a Differential Communication Signal	60
TDS 210 and TDS 220 (Firmware V 2.00 and Above), and TDS 224 (All Versions) Oscilloscopes	61
TDS 210 and TDS 220 Oscilloscopes (Firmware Below V 2.00) without a TDS2MM	62
TDS 210 and TDS 220 Oscilloscopes (Firmware Below V 2.00) with a TDS2MM	62
Viewing Impedance Changes in a Network	63

Reference	65
Acquire	66
Autoset	70
Cursors	71
Display	72
Horizontal	74
Math	76
TDS 210 and TDS 220 (Firmware V 2.00 and Above) and TDS 224 (All Versions) Oscilloscopes	76
TDS 210 and TDS 220 Oscilloscopes (Firmware Below V 2.00) without a TDS2MM	77
TDS 210 and TDS 220 Oscilloscopes (Firmware Below V 2.00) with a TDS2MM	77
Measure	79
Save/Recall	81
Trigger Controls	83
Utility	87
Vertical	89
Hard Copy	90
Appendix A: Specifications	91
Appendix B: Accessories	103
Appendix C: General Care and Cleaning	107
Glossary	109
Index	115

General Safety Summary

Review the following safety precautions to avoid injury and prevent damage to this product or any products connected to it. To avoid potential hazards, use this product only as specified.

Only qualified personnel should perform service procedures.

To Avoid Fire or Personal Injury

Use Proper Power Cord. Use only the power cord specified for this product and certified for the country of use.

Connect and Disconnect Properly. Do not connect or disconnect probes or test leads while they are connected to a voltage source.

Ground the Product. This product is grounded through the grounding conductor of the power cord. To avoid electric shock, the grounding conductor must be connected to earth ground. Before making connections to the input or output terminals of the product, ensure that the product is properly grounded.

Connect the Probe Properly. The probe ground lead is at ground potential. Do not connect the ground lead to an elevated voltage.

Observe All Terminal Ratings. To avoid fire or shock hazard, observe all ratings and marking on the product. Consult the product manual for further ratings information before making connections to the product.

Do Not Operate Without Covers. Do not operate this product with covers or panels removed.

Use Proper Fuse. Use only the fuse type and rating specified for this product.

Avoid Exposed Circuitry. Do not touch exposed connections and components when power is present.

Do Not Operate With Suspected Failures. If you suspect there is damage to this product, have it inspected by qualified service personnel.

Provide Proper Ventilation. Refer to the manual's installation instructions for details on installing the product so it has proper ventilation.

Do Not Operate in Wet/Damp Conditions.

Do Not Operate in an Explosive Atmosphere.

Keep Product Surfaces Clean and Dry.

Safety Terms and Symbols

Terms in This Manual. These terms may appear in this manual:



WARNING. *Warning statements identify conditions or practices that could result in injury or loss of life.*



CAUTION. *Caution statements identify conditions or practices that could result in damage to this product or other property.*

Terms on the Product. These terms may appear on the product:

DANGER indicates an injury hazard immediately accessible as you read the marking.

WARNING indicates an injury hazard not immediately accessible as you read the marking.

CAUTION indicates a hazard to property including the product.

Symbols on the Product. These symbols may appear on the product:



Protective Ground
(Earth) Terminal



Measurement
Ground Terminal



CAUTION
Refer to Manual



Measurement
Input Terminal



Contacting Tektronix

Product support	<p>For questions about using Tektronix measurement products, call toll free in North America: 1-800-833-9200 6:00 a.m. – 5:00 p.m. Pacific time</p> <p>Or contact us by e-mail: support@tektronix.com</p> <p>For product support outside of North America, contact your local Tektronix distributor or sales office.</p>
Service support	<p>Tektronix offers extended warranty and calibration programs as options on many products. Contact your local Tektronix distributor or sales office.</p> <p>For a listing of worldwide service centers, visit our web site.</p>
For other information	<p>In North America: 1-800-833-9200 An operator can direct your call.</p>
To write us	<p>Tektronix, Inc. P.O. Box 500 Beaverton, OR 97077-0001 USA</p>
Web site	<p>www.tektronix.com</p>

Getting Started

TDS 200-Series Digital Oscilloscopes are small, lightweight, benchtop packages that you can use to take ground-referenced measurements. The TDS 210 and TDS 220 oscilloscopes have two-channels; the TDS 224 has four channels.

In addition to the list of general features, this section covers the following topics:

- How to install your product
- How to add extended functions
- How to perform a brief functional check
- How to compensate probes
- How to use the self calibration routine
- How to match your probe attenuation factor

NOTE. *To select a display language, push the **UTILITY** menu button, and then push the Language menu box item to select the appropriate language.*

General Features

- 100 MHz (TDS 220 or TDS 224) or 60 MHz (TDS 210) bandwidth with selectable 20 MHz bandwidth limit
- 1 GS/s sample rate and 2,500 point record length for each channel
- Cursors with readout
- Five automated measurements
- High-resolution, high-contrast LCD display with temperature compensation and replaceable back light
- Setup and waveform storage
- Autoset for quick setup
- Waveform averaging and peak detection
- Digital real-time oscilloscope
- Dual time base
- Video trigger capability
- RS-232, GPIB, and Centronics communication ports easily added with optional extension modules
- Variable persistence display
- User interface available in ten user-selectable languages

Installation

Power Cord

Use only power cords designed for your oscilloscope. Use a power source that delivers 90 to 264 VAC_{RMS}, 45 to 440 Hz. Refer to page 105 for a list of available power cords.

Use the power cord notch to help route the cord to the rear of the instrument and avoid inadvertently disconnecting the power source.

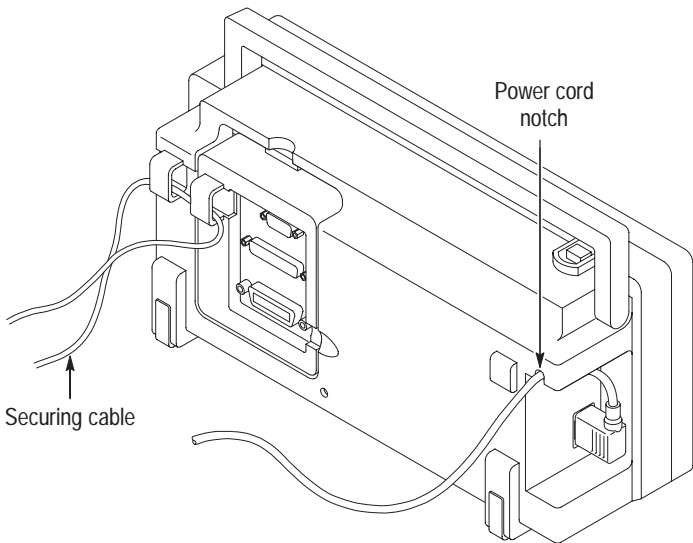

Security Loop

Use the built-in cable channels to secure both your instrument and extension module to your location.

Extension Modules

You can increase the feature set of your oscilloscope by inserting an extension module. Refer to page 103 for information about the available modules.



CAUTION. *Electrostatic discharge (ESD) can damage components in the extension module and the oscilloscope. Do not operate your instrument with the extension module connector exposed.*

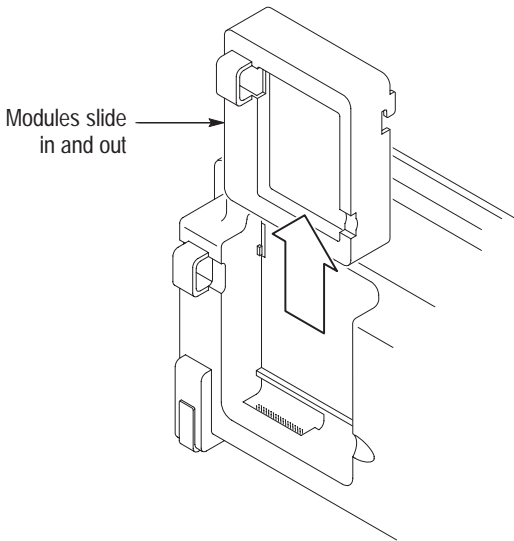

Functional Check

Perform this quick functional check to verify that your instrument is operating correctly.

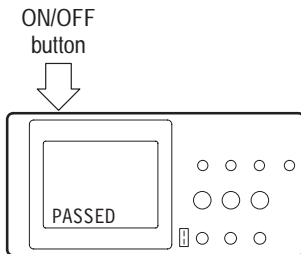

1. Turn on the instrument.

Wait until the display shows that all self tests passed. Push the SAVE/RECALL button, select Setups in the top menu box and push the Recall Factory menu box. The default Probe menu attenuation setting is 10X.

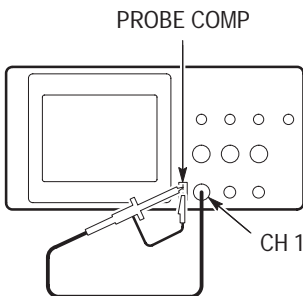

2. Set the switch to 10X on the P2100 probe and connect the probe to channel 1 on the oscilloscope. To do this, align the slot in the probe connector with the key on the CH 1 BNC, push to connect, and twist to the right to lock the probe in place.

Attach the probe tip and reference lead to the PROBE COMP connectors.

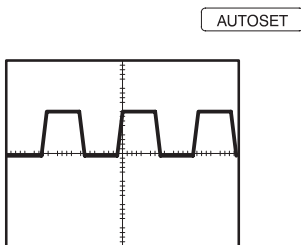

3. Push the AUTOSET button. Within a few seconds, you should see a square wave in the display (approximately 5 V at 1 kHz peak-to-peak).

Push the CH 1 MENU button twice to turn off channel 1, push the CH 2 MENU button to turn on channel 2, repeat steps 2 and 3. For TDS 224, repeat for CH 3 and CH 4.

Probe Compensation

Perform this adjustment to match your probe to the input channel. This should be done whenever you attach a probe for the first time to any input channel.

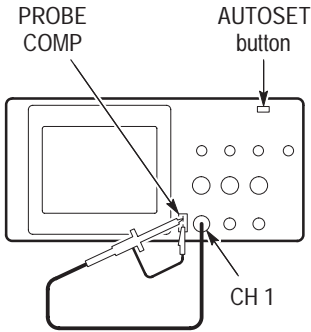

1. Set the Probe menu attenuation to 10X. Set the switch to 10X on the P2100 probe and connect the probe to channel 1 on the oscilloscope. If you use the probe hook-tip, ensure a proper connection by firmly inserting the tip onto the probe.

Attach the probe tip to the PROBE COMP 5V connector and the reference lead to the PROBE COMP Ground connector, turn on the channel, and then press AUTOSET.



2. Check the shape of the displayed waveform.

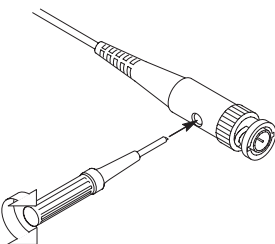

3. If necessary, adjust your probe.

Repeat as necessary.

Self Calibration

The self calibration routine lets you quickly optimize the oscilloscope signal path for maximum measurement accuracy. You can run the routine at anytime but you should always run the routine if the ambient temperature changes by 5° C or more.

To compensate the signal path, disconnect any probes or cables from the input connectors. Then, press the UTILITY button and select Do Self Cal to confirm that you are ready to proceed.

Probe Safety

A guard around the probe body provides a finger barrier for protection from electric shock.

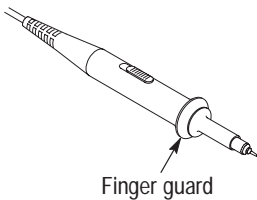

WARNING. To avoid electric shock when using the probe, keep fingers behind the guard on the probe body.

To avoid electric shock while using the probe, do not touch metallic portions of the probe head while it is connected to a voltage source.

Connect the probe to the instrument and connect the ground terminal to ground before you take any measurements.

Probe Attenuation Setting

Probes are available with various attenuation factors which affect the vertical scale of the signal.

To change (or check) the probe attenuation setting, press the VERTICAL MENU button (of the channel you are using), and then press the menu selection next to Probe until the correct setting is displayed.

This setting remains in effect until changed again.

NOTE. The default Probe menu attenuation setting is 10X when the oscilloscope is shipped.

Be sure that the Attenuation switch on the P2100 probe is set to match the Probe menu selection in the oscilloscope. The probe switch settings are 1X and 10X.

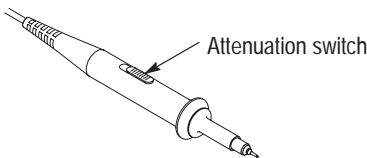

NOTE. When the Attenuation switch is set to 1X, the P2100 probe limits the bandwidth of the oscilloscope to 7 MHz. To use the full bandwidth of the oscilloscope, be sure to set the switch to 10X.

Basic Concepts

To use your oscilloscope effectively, you must understand the following basic concepts:

- Triggering
- Acquiring data
- Scaling and positioning waveforms
- Measuring waveforms
- Setting Up the oscilloscope

The figure below shows a block diagram of the various functions of an oscilloscope and their relationship to each other.

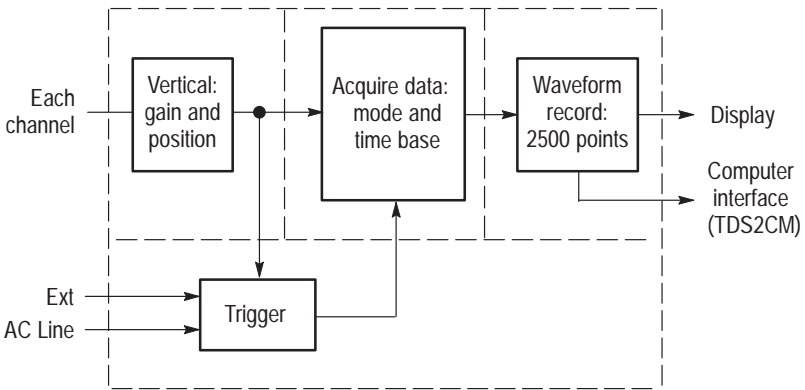

Triggering

The trigger determines when the oscilloscope starts to acquire data and display a waveform. When a trigger is set up properly, it can convert unstable displays or blank screens into meaningful waveforms.

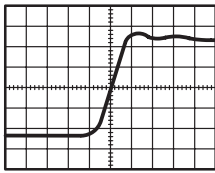

Triggered waveform

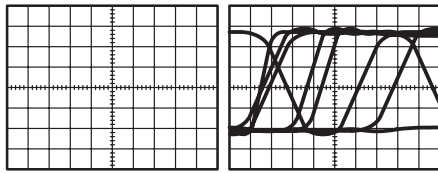

Untriggered waveforms

When the oscilloscope starts to acquire a waveform, it collects enough data so that it can draw the waveform to the left of the trigger point. The oscilloscope continues to acquire data while waiting for the trigger condition to occur. After it detects a trigger, the oscilloscope continues to acquire enough data so that it can draw the waveform to the right of the trigger point.

Source

You can derive your trigger from various sources: Input channels, AC Line, and External.

Input. The most commonly used trigger source is any one of the input channels. The channel you select as a trigger source will function whether it is displayed or not.

AC Line. You can use this trigger source when you want to look at signals related to the power line frequency, such as lighting equipment and power supply devices. The oscilloscope generates the trigger, so you do not have to input a trigger signal.

External (TDS 210 and TDS 220 Only). You can use this trigger source when you want to acquire data on two channels and trigger from a third. For example, you might want to trigger from an external clock or with a signal from another part of the test circuit.

The EXT and EXT/5 trigger sources both use the external trigger signal connected to the EXT TRIG connector. EXT uses the signal directly; you can use EXT on signals with a trigger level range of +1.6 V to – 1.6 V.

The EXT/5 trigger source divides the signal by 5 which extends the trigger level range from + 8 V to – 8 V. This allows the oscilloscope to trigger on a larger signal.

Types

The oscilloscope provides two types of triggers: Edge and Video.

Edge. You can use the edge trigger with analog and digital test circuits. An edge trigger occurs when the trigger input passes through a specified voltage level in the specified direction.

Video. You can use the video trigger on fields or lines of standard video signals. Refer to *Triggering on a Video Signal* on page 53.

Modes

The trigger mode determines how the oscilloscope behaves in the absence of a trigger event. The oscilloscope provides three trigger modes: Auto, Normal, and Single.

Auto. This trigger mode allows the oscilloscope to acquire a waveform even when it does not detect a trigger condition. If no trigger condition occurs while the oscilloscope waits for a specific period (as determined by the time-base setting), it will force itself to trigger.

Refer to *Time Base* on page 16 for more information on time bases.

When forcing invalid triggers, the oscilloscope cannot synchronize the waveform, and the waveform seems to roll across the display. If valid triggers occur, the display becomes stable on the screen.

You can use Auto mode to monitor an amplitude level, such as a power supply output, which may cause the waveform to roll across the display.

Normal. The Normal mode allows the oscilloscope to acquire a waveform only when it is triggered. If no trigger occurs, the oscilloscope will not acquire a new waveform, and the previous waveform, if any, will remain on the display.

Single. The Single mode allows the oscilloscope to acquire one waveform each time you press the RUN button, and the trigger condition is detected.

The data that the oscilloscope acquires depends on the acquisition mode. Refer to *Acquisition Modes* on page 15 for more information on the type of data each acquisition mode will acquire.

NOTE. *When you use the Single trigger mode with the Average acquisition mode, the number of waveforms specified in the number of averages are acquired before the acquisition stops.*

Holdoff

Triggers are not recognized during holdoff time (the period that follows each acquisition). For some signals, you need to adjust the holdoff period to produce a stable display.

The trigger signal can be a complex waveform with many possible trigger points on it, such as a digital pulse train. Even though the waveform is repetitive, a simple trigger might result in a series of patterns on the screen instead of the same pattern each time.

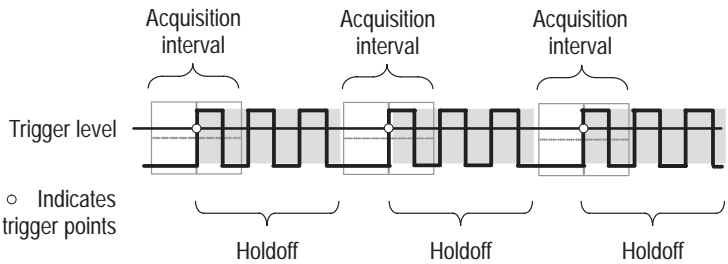

Triggers are not recognized during holdoff time.

For example, you could use the holdoff period to prevent triggering on any other pulse except the first one in a pulse train. This way, the oscilloscope would always display the first pulse.

To access the Holdoff control, press the HORIZONTAL Menu button, select Holdoff, and use the HOLDOFF knob to change the amount of time in the holdoff period.

Coupling

Trigger coupling determines what part of the signal passes on to the trigger circuit. Coupling types include DC, AC, Noise Rejection, High Frequency Rejection, and Low Frequency Rejection.

DC. DC coupling passes both AC and DC components.

AC. AC coupling blocks DC components.

Noise Rejection. Noise Reject coupling lowers the trigger sensitivity and requires more signal amplitude for stable triggering. This reduces the chance of falsely triggering on noise.

High Frequency Rejection. HF Reject coupling blocks the high frequency portion and passes on only the low frequency components.

Low Frequency Rejection. LF Reject coupling does the opposite of high frequency rejection.

Position

The horizontal position control establishes the time between the trigger and the screen center. Refer to *Horizontal Scale and Position; Pretrigger Information* on page 17 for more information on how to use this control to position the trigger.

Slope and Level

The Slope and Level controls help to define the trigger.

The Slope control determines whether the oscilloscope finds the trigger point on the rising or the falling edge of a signal. To access the trigger slope control, press the TRIGGER Menu button, select Edge, and use the Slope button to select Rising or Falling.

The Level control determines where on the edge the trigger point occurs. To access the trigger level control, press the HORIZONTAL Menu button, select Level, and use the LEVEL knob to change the value.

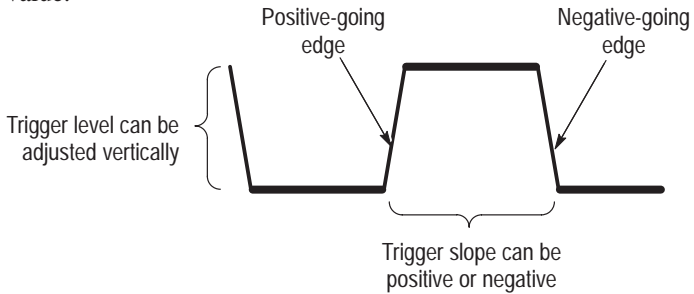

Acquiring Data

When you acquire analog data, the oscilloscope converts it into a digital form. You can acquire data using three different acquisition modes. The timebase setting affects how rapidly data is acquired.

Acquisition Modes

There are three acquisition modes: Sample, Peak Detect, and Average.

Sample. In this acquisition mode, the oscilloscope samples the signal in evenly spaced intervals to construct the waveform. This mode accurately represents analog signals most of the time.

However, this mode does not acquire rapid variations in the analog signal that may occur between samples. This can result in aliasing (described on page 18) and may cause narrow pulses to be missed. In these cases, you should use the Peak Detect mode to acquire data.

Peak Detect. In this acquisition mode, the oscilloscope finds the highest and lowest values of the input signal over a sample interval and uses these values to display the waveform. In this way, the oscilloscope can acquire and display narrow pulses, which may have otherwise been missed in Sample mode. Noise will appear to be higher in this mode.

Average. In this acquisition mode, the oscilloscope acquires several waveforms, averages them, and displays the resulting waveform. You can use this mode to reduce random noise.

Time Base

The oscilloscope digitizes waveforms by acquiring the value of an input signal at discrete points. The time base allows you to control how often the values are digitized.

To adjust the time base to a horizontal scale that suits your purpose, use the SEC/DIV knob.

Scaling and Positioning Waveforms

You can change the display of waveforms by adjusting their scale and position. When you change the scale, the waveform display will increase or decrease in size. When you change the position, the waveform will move up, down, right, or left.

The channel reference indicator (located on the left of the graticule) identifies each waveform on the display. The indicator points to the ground level of the waveform record.

Vertical Scale and Position

You can change the vertical position of waveforms by moving them up or down on the display. To compare data, you can align a waveform above another or you can align waveforms on top of each other.

You can change the vertical scale of a waveform. The waveform display will contract or expand about the ground level.

Horizontal Scale and Position; Pretrigger Information

You can adjust the Horizontal Position control to view waveform data before the trigger, after the trigger, or some of each. When you change the horizontal position of a waveform, you are actually changing the time between the trigger and the center of the display. (This appears to move the waveform to the right or left on the display.)

For example, if you want to find the cause of a glitch in your test circuit, you might trigger on the glitch and make the pretrigger period large enough to capture data before the glitch. You can then analyze the pretrigger data and perhaps find the cause of the glitch.

You change the horizontal scale of all the waveforms by using the SEC/DIV knob. For example, you might want to see just one cycle of a waveform to measure the overshoot on its rising edge.

The oscilloscope shows the time per division in the scale readout. Since all active waveforms use the same time base, the oscilloscope only displays one value for all the active channels, except when you use a Window Zone.

Aliasing. Aliasing occurs when the oscilloscope does not sample the signal fast enough to construct an accurate waveform record. When aliasing happens, you see a waveform with a frequency lower than the actual waveform being input or a waveform that is not stable even though the oscilloscope triggered.

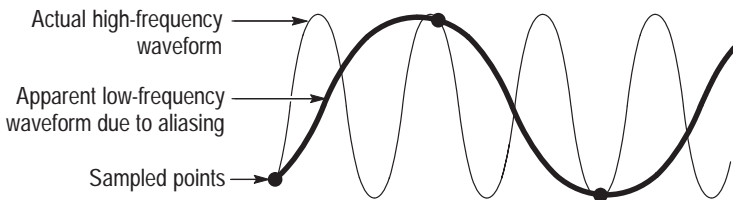

One way to check for aliasing is to slowly change the horizontal scale with the SEC/DIV knob. If the shape of the waveform changes drastically, you may have aliasing.

To represent a signal accurately and avoid aliasing, you must sample the signal more than twice as fast as the highest frequency component. For example, a signal with frequency components of 5 MHz would need to be sampled at 10 Megasamples per second or faster.

The next table lists the time bases that you should use to avoid aliasing at various frequencies and the respective sample rate.

Time base	Samples per second	Maximum frequency	Time base	Samples per second	Maximum frequency
1.0 μ s	250.0 MS/s	125.0 MHz*	5.0 ms	50.0 kS/s	25.0 kHz
2.5 μ s	100.0 MS/s	50.0 MHz*	10.0 ms	25.0 kS/s	12.5 kHz
5.0 μ s	50.0 MS/s	25.0 MHz*	25.0 ms	10.0 kS/s	5.0 kHz
10.0 μ s	25.0 MS/s	12.5 MHz*	50.0 ms	5.0 kS/s	2.5 kHz
25.0 μ s	10.0 MS/s	5.0 MHz*	100.0 ms	2.5 kS/s	1.25 kHz
50.0 μ s	5.0 MS/s	2.5 MHz	250.0 ms	1.0 S/s	500.0 Hz
100.0 μ s	2.5 MS/s	1.25 MHz	500.0 ms	500.0 S/s	250.0 Hz
250.0 μ s	1.0 MS/s	500.0 kHz	1.0 s	250.0 S/s	125.0 Hz
500.0 μ s	500.0 kS/s	250.0 kHz	2.5 s	100.0 S/s	50.0 Hz
1.0 ms	250.0 kS/s	125.0 kHz	5.0 s	50.0 S/s	25.0 Hz
2.5 ms	100.0 kS/s	50.0 kHz			

* Bandwidth is not valid for the P2100 probe when the switch is set to 1X.

There are various ways to prevent aliasing: adjust the horizontal scale, push the AUTOSSET button, or change the acquisition mode.

NOTE. If aliasing occurs, change to the Peak Detect acquisition mode (described on page 16). This mode samples the highest and lowest values so that the oscilloscope can detect faster signals.

Taking Measurements

The oscilloscope displays graphs of voltage versus time and can help you to measure the displayed waveform.

There are several ways to take measurements. You can use the graticule, the cursors, or an automated measurement.

Graticule

This method allows you to make a quick, visual estimate. For example, you might look at a waveform amplitude and determine that it is a little more than 100 mV.

You can take simple measurements by counting the major and minor graticule divisions involved and multiplying by the scale factor.

For example, if you counted five major vertical graticule divisions between the minimum and maximum values of a waveform and knew you had a scale factor of 100 mV/division, then you could easily calculate your peak-to-peak voltage as follows:

$$5 \text{ divisions} \times 100 \text{ mV/division} = 500 \text{ mV.}$$

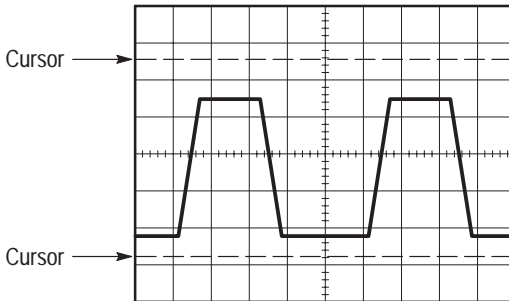

Cursors

This method allows you to take measurements by moving the cursors, which always appear in pairs, and reading their numeric values from the display readouts. There are two types of cursors: Voltage and Time.

When you use cursors, be sure to set the Source to the waveform that you want to measure.

Voltage Cursors. Voltage cursors appear as horizontal lines on the display and measure the vertical parameters.

Time Cursors. Time cursors appear as vertical lines on the display and measure the horizontal parameters.

Automated

When you take automated measurements, the oscilloscope does all the calculating for you. Because these measurements use the waveform record points, they are more accurate than graticule or cursor measurements.

Automated measurements use readouts to show measurement results. These readouts are updated periodically as the oscilloscope acquires new data.

Setting Up the Oscilloscope

You should become familiar with three functions that you will use often when operating your oscilloscope: Autoset, saving a setup, and recalling a setup. Included is a description of the default settings for normal operation of the oscilloscope.

Using Autoset

The Autoset function obtains a stable waveform display for you. It automatically adjusts the vertical and horizontal scaling, as well as the trigger coupling, type, position, slope, level, and mode settings.

Saving a Setup

By default, the oscilloscope saves the setup each time it is powered off. The oscilloscope automatically recalls this setup the next time it is powered on.

NOTE. *You should wait at least five seconds after your last change to the setup before you turn off the power. This ensures that the setup is saved properly.*

You can also permanently save up to five setups in the memory of the oscilloscope and overwrite setups as needed.

Recalling a Setup

The oscilloscope can recall any of the saved setups or the factory default setup.

Defaults (Factory Setup)

The oscilloscope is set up for normal operation when it is shipped from the factory. You can recall the factory default setup any time you want to operate the oscilloscope using or starting from the factory default settings.

Operating Basics

The front panel is divided into easy to use functional areas. This section provides you with a quick overview of the controls and the information displayed on the screen. The next figure shows the front panels for a TDS 210 or TDS 220, and for a TDS 224 oscilloscope.

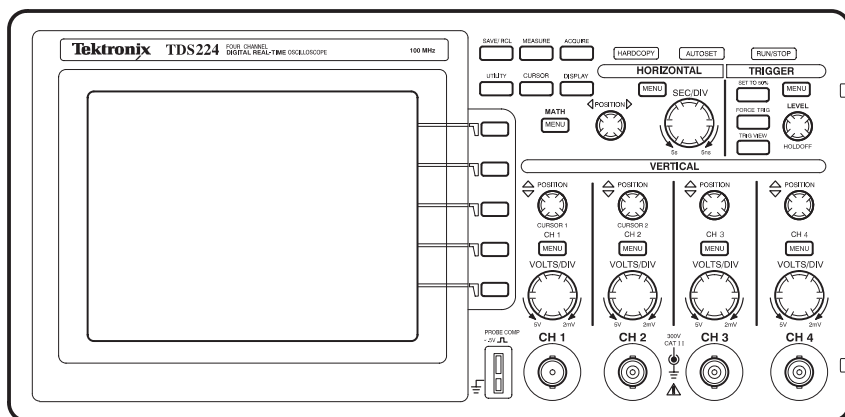
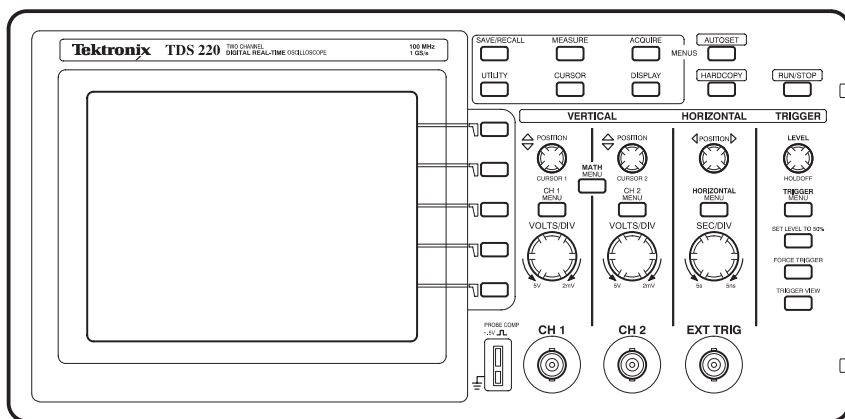

Display Area

In addition to displaying waveforms, the display is filled with many details about the waveform and the instrument control settings.

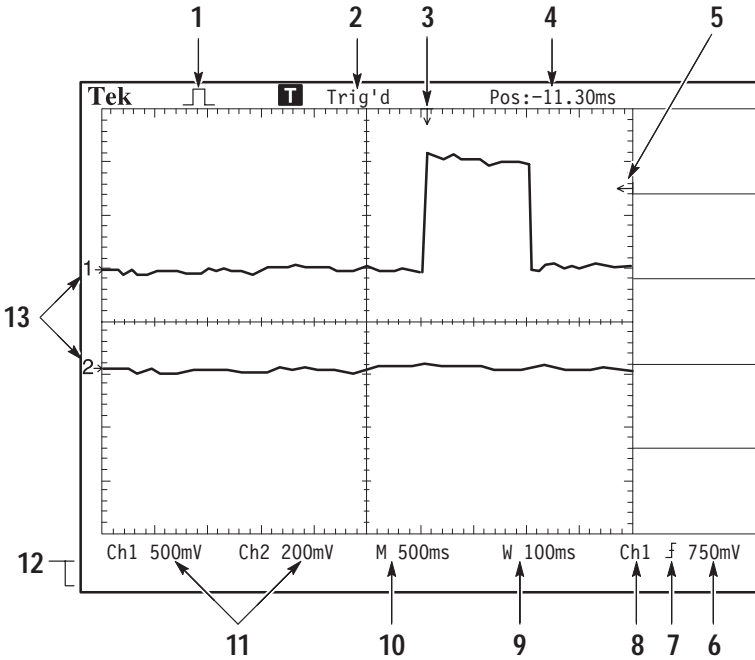

1. Icon display shows acquisition mode.







Sample mode



Peak detect mode



Average mode

2. Trigger status indicates the following:
 - Armed. The instrument is acquiring pretrigger data. All triggers are ignored in this state.
 - Ready. All pretrigger data has been acquired and the instrument is ready to accept a trigger.
 - Trig'd. The instrument has seen a trigger and is acquiring the posttrigger data.
 - Auto. The instrument is in auto mode and is acquiring waveforms in the absence of triggers.
 - Scan. The instrument is acquiring and displaying waveform data continuously in scan mode.
 - Stop. The instrument has stopped acquiring waveform data.
3. Marker shows horizontal trigger position. This is adjusted by the Horizontal Position control.
4. Readout shows the time difference between the center graticule and horizontal trigger position. Center screen equals zero.
5. Marker shows trigger level.
6. Readout shows numeric value of the trigger level.
7. Icon shows selected trigger type as follows:
 -  – Edge trigger for the rising edge.
 -  – Edge trigger for the falling edge.
 -  – Video trigger for line sync.
 -  – Video trigger for field sync.

8. Readout shows trigger source used for triggering.
9. Readout shows window time base setting if it is in use.
10. Readout shows main time base setting.
11. Readouts show the vertical scale factors of the channels.
12. Display area shows on-line messages momentarily.
13. On-screen markers show the ground reference points of the displayed waveforms. No marker indicates the channel is not displayed.

Using the Menu System

The user interface of the TDS 200-series oscilloscopes was designed for easy access to specialized functions through the menu structure.

When you press a menu button on the front panel, the associated menu title displays at the top right of the screen. There can be up to five menu boxes below the menu title. To the right of each menu box is a bezel button you can use to change the menu setting.

There are four types of menu boxes you can use to change settings: Circular Lists, Action Buttons, Radio Buttons, and Page Selections.

Circular List Menu Boxes

A Circular List menu box appears with a title on top with the selected choice listed below in reverse video. For example, you can push the menu box button to cycle through the vertical coupling choices in the CH1 Menu.

Action Button Menu Boxes

An Action Button menu box displays the name of the action. For example, you can use the two lowest menu boxes in the DISPLAY menu to increase or decrease the contrast.

Radio Button Menu Boxes

Radio Button menu boxes are separated by dashed lines. The name of the selected menu box displays in reverse video. For example, you can use the top three menu boxes in the ACQUIRE menu to select an acquisition mode.

Page Selection Menu Boxes

A Page Selection menu box contains two menus for a single button on the front panel with the selected menu displayed in reverse video. Each time you press the top menu box button to toggle between the two menus, the menu boxes below also change.

For example, when you press the SAVE/RECALL front panel button, the top Page Selection menu contains the names of two menus: Setups and Waveforms. When you select the Setups menu, you can use the remaining menu boxes to save or recall setups. When you select the Waveforms menu, you can use the remaining menu boxes to save or recall waveforms.

The SAVE/RECALL, MEASURE, and TRIGGER front panel buttons display Page Selection menu boxes.

Circular List

CH1
Coupling DC
OR
CH1
Coupling AC
OR
CH1
Coupling Ground

Action Button

DISPLAY
Type Vectors
Persist Off
Format YT
Contrast Increase
Contrast Decrease

Radio Button

ACQUIRE
Sample
Peak detect
Average
Averages 16

Page Selection

SAVE/REC	SAVE/REC
Setups Waveforms	Setups Waveforms
Recall Factory	Source CH1
Setup 1	Ref A
Save	Save
Recall	Ref A Off

Waveform Displays

Obtaining a waveform display is dependent on many instrument settings. Once you obtain a waveform, you can take your measurements. But the appearance of these waveforms also provides key information about the waveform.

Depending on the type, waveforms will be displayed in three different styles: black, gray, and broken.

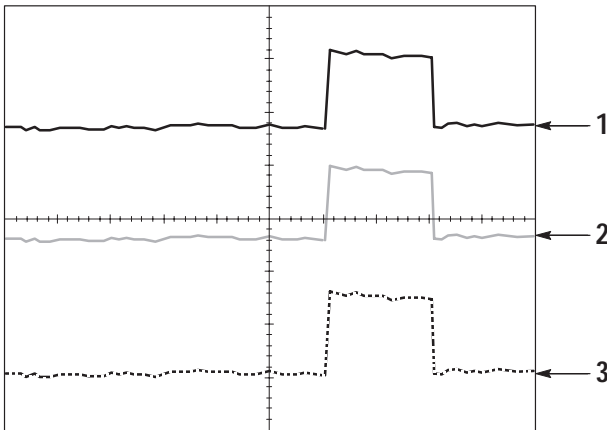

1. A solid black waveform indicates a live waveform display. The waveform remains black when the acquisition is stopped if no controls are changed that make the display accuracy uncertain.

Changing the vertical and horizontal controls is allowed on stopped acquisitions.

2. Reference waveforms and waveforms with persistence applied appear gray.
3. A broken line appearance indicates the waveform display accuracy is uncertain. This is the result of stopping the acquisition and then changing a control setting that the instrument cannot modify the displayed waveform to match. For example, changing the trigger controls on a stopped acquisition causes a broken-line waveform.

Vertical Controls

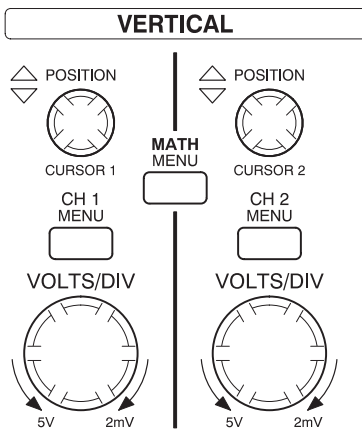

TDS 210 and TDS 220

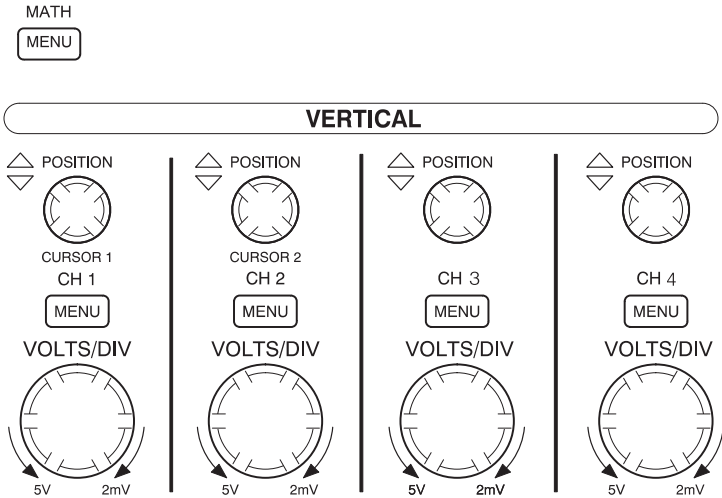

TDS 224

CH 1, 2, 3 & 4 and CURSOR 1 & 2 POSITION. Positions the waveform vertically. When cursors are turned on and the cursor menu is displayed, these knobs position the cursors.

CH 1, CH 2, CH 3 & CH 4 MENU. Displays the channel input menu selections and toggles the channel display on and off.

VOLTS/DIV (CH1, CH 2, CH 3 & CH 4). Selects calibrated scale factors.

MATH MENU. Displays waveform math operations menu and can also be used to toggle the math waveform on and off.

Horizontal Controls

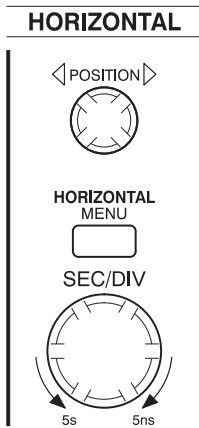

TDS 210 and TDS 220

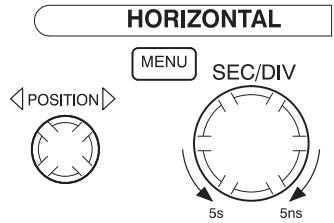

TDS 224

POSITION. Adjusts the horizontal position of all channels and math waveforms. The resolution of this control varies with the time base.

NOTE. To make a large adjustment to the horizontal position, change the *SEC/DIV* to 50 ms, change the horizontal position, and then change the *SEC/DIV* back to the previous value.

HORIZONTAL MENU. Displays the horizontal menu.

SEC/DIV. Selects the horizontal time/div (scale factor) for the main or the window time base. When Window Zone is enabled, it changes the width of the window zone by changing the window time base. Refer to page 75 for details about creating and using the Window Zone.

Trigger Controls

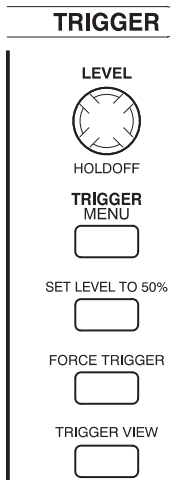

TDS 210 and TDS 220

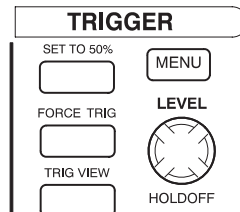

TDS 224

LEVEL and HOLDOFF. This control has a dual purpose. As an edge trigger level control, it sets the amplitude level the signal must cross to cause an acquisition. As a holdoff control, it sets the amount of time before another trigger event can be accepted. Refer to *Holdoff* on page 13 for more information.

TRIGGER MENU. Displays the trigger menu.

SET LEVEL TO 50%. The trigger level is set to the vertical midpoint between the peaks of the trigger signal.

FORCE TRIGGER. Starts an acquisition regardless of an adequate trigger signal. This button has no effect if the acquisition is already stopped.

TRIGGER VIEW. Displays the trigger waveform in place of the channel waveform while the TRIGGER VIEW button is held down. You can use this to see how the trigger settings affect the trigger signal, such as trigger coupling.

Menu and Control Buttons

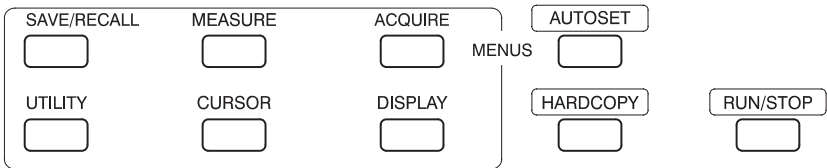

TDS 210 and TDS 220



TDS 224

SAVE/RECALL. Displays the save/recall menu for setups and waveforms.

MEASURE. Displays the automated measurements menu.

ACQUIRE. Displays the acquisition menu.

DISPLAY. Displays the display menu.

CURSOR. Displays the cursor menu. Vertical Position controls adjust cursor position while displaying the cursor menu and the cursors are turned on. Cursors remain displayed (unless turned off) after leaving the cursor menu but are not adjustable.

UTILITY. Displays the utility menus.

AUTOSET. Automatically sets the instrument controls to produce a usable display of the input signal.

HARDCOPY. Starts print operations. An extension module with a Centronics, RS-232, or GPIB port is required. Refer to *Optional Accessories* on page 103.

RUN/STOP. Starts and stops waveform acquisition.

Connectors

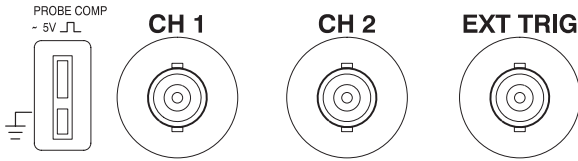

TDS 210 and TDS 220

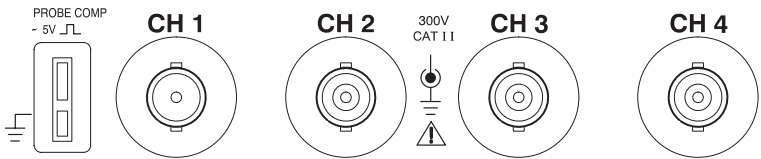

TDS 224

PROBE COMP. Voltage probe compensation output and ground. Use this to electrically match the probe to the input circuit. Refer to page 6.

The probe compensation ground and BNC shields are connected to earth ground. Do not connect a voltage source to these ground terminals.

CH 1, CH 2, CH 3 & CH 4. Input connectors for waveform display.

EXT TRIG. Input connector for an external trigger source. Use the trigger menu to select the trigger source.

Application Examples

This section presents a series of application examples. These simplified examples highlight the features of the oscilloscope and give you ideas for using it to solve your own test problems.

- Taking simple measurements
 - Using Autoset
 - Using the Measure menu to take automatic measurements
 - Measuring two signals and calculating gain
- Taking cursor measurements
 - Measuring pulse width
 - Measuring rise time
 - Measuring ring frequency and ring amplitude
- Analyzing signal detail
 - Looking at a noisy signal
 - Using the average function to separate a signal from noise
- Triggering on a video signal
 - Triggering on video fields and video lines
 - Using the window function to see waveform details
 - Triggering on odd or even video fields
- Analyzing a differential communication signal
 - Using math functions
- Viewing impedance changes in a network
 - Using XY mode
 - Using persistence

Taking Simple Measurements

You need to see a signal in a circuit, but you do not know the amplitude or frequency of the signal. You want to quickly display the signal and measure the frequency, period, and peak-to-peak amplitude.

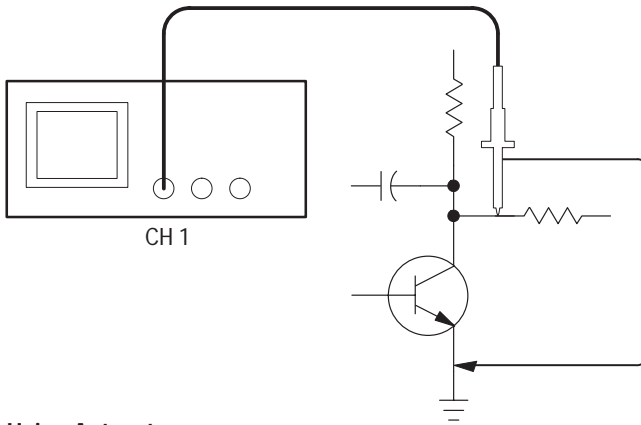

Using Autoset

To quickly display a signal, do these steps:

1. Connect the channel 1 probe to the signal.
2. Push the **AUTOSET** button.

The oscilloscope sets the vertical, horizontal, and trigger controls automatically. If you want to optimize the display of the waveform, you can manually adjust these controls.

When you use more than one channel, the autoset function sets the vertical controls for each channel and uses the lowest-numbered active channel to set the horizontal and trigger controls.

Taking Automatic Measurements

The oscilloscope can take automatic measurements of most displayed signals. To measure signal frequency, period, and peak-to-peak amplitude, do these steps:

1. Push the **MEASURE** button to see the Measure menu.
2. Push the top menu box button to select **Source**.
3. Select **CH1** for the first three measurements.
4. Push the top menu box button to select **Type**.
5. Push the first **CH1** menu box button to select **Freq.**
6. Push the second **CH1** menu box button to select **Period**.
7. Push the third **CH1** menu box button to select **Pk-Pk**.

The frequency, period, and peak-to-peak measurements are shown in the menu and are updated periodically.

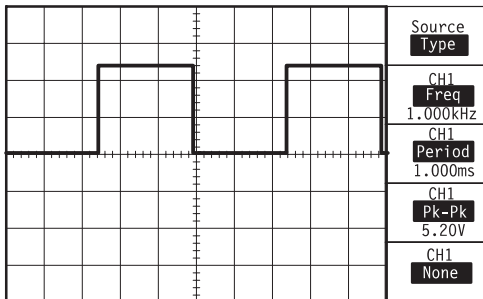

Measuring Two Signals

You are testing a piece of equipment and need to measure the gain of the audio amplifier. You have an audio generator that can inject a test signal at the amplifier input. Connect two oscilloscope channels to the amplifier input and output as shown. Measure both signal levels and use the measurements to calculate the gain.

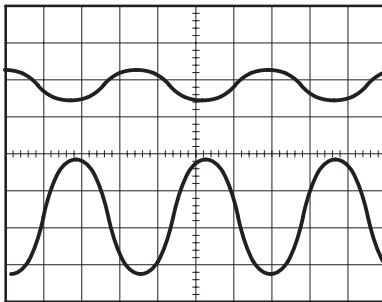
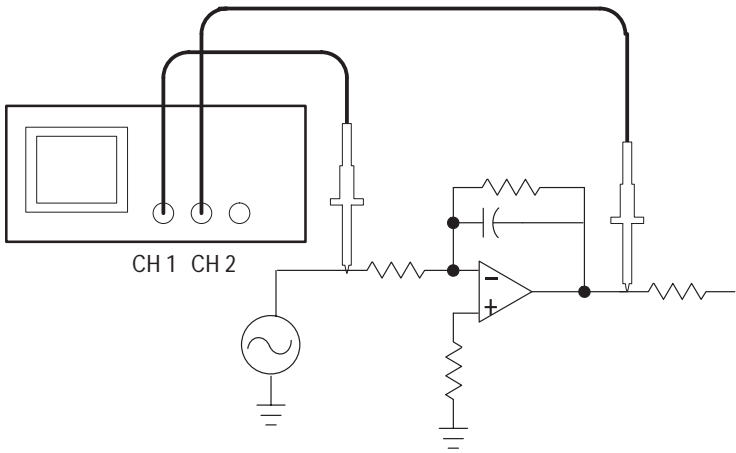

To activate and display the signals connected to channel 1 and to channel 2, do these steps:

1. If the channels are not displayed, push the **CH 1 MENU** and then **CH 2 MENU** buttons.
2. Push the **AUTOSET** button.

To select measurements for the two channels, do these steps:

1. Select the source channels.
 - a. Push the **MEASURE** button to see the Measure menu.
 - b. Push the top menu box button to select **Source**.
 - c. Push the second menu box button to select **CH1**.
 - d. Push the third menu box button to select **CH2**.
2. Select the type of measurement displayed for each channel.
 - a. Push the top menu box button to select **Type**.
 - b. Push the **CH1** menu box button to select **Pk-Pk**.
 - c. Push the **CH2** menu box button to select **Pk-Pk**.
3. Read the peak-to-peak amplitudes for channel 1 and channel 2 in the menu display.
4. Calculate the amplifier gain using the following equations:

$$Gain = \frac{\text{output amplitude}}{\text{input amplitude}}$$

$$Gain (dB) = 20 \times \log(Gain)$$

Taking Cursor Measurements

You can use the cursors to quickly take time and voltage measurements on a waveform.

Measuring Pulse Width

You are analyzing a pulse waveform, and you want to know the width of the pulse. To measure the width of a pulse using the time cursors, do these steps:

1. Push the **CURSOR** button to see the Cursor menu.
2. Push the top menu box button to select **Time**.
3. Push the **Source** menu box button to select CH1.
4. Use the **CURSOR 1** knob to place a cursor on the rising edge of the pulse.
5. Use the **CURSOR 2** knob to place the remaining cursor on the falling edge of the pulse.

You can see the following measurements in the Cursor menu:

- The time at Cursor 1, relative to the trigger.
- The time at Cursor 2, relative to the trigger.
- The delta time, which is the pulse width measurement.

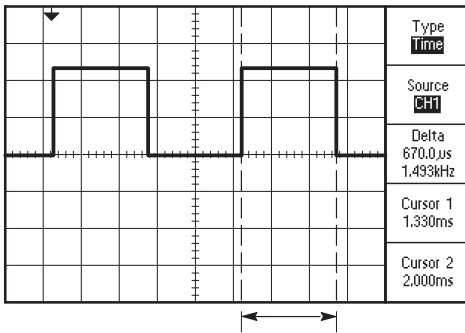

NOTE. The TDS2MM extension module provides pulse width as an automatic measurement.

Measuring Rise Time

After measuring the pulse width, you decide that you need to check the rise time of the pulse. Typically, you measure rise time between the 10% and 90% portion of the waveform. To measure the rise time, do these steps:

1. Adjust the **SEC/DIV** knob to display the rising edge of the waveform.
2. Adjust the **VOLTS/DIV** knob to set the waveform amplitude to about five divisions.
3. Push the **CH 1 MENU** button to see the CH1 menu if it is not displayed.
4. Push the **Volts/Div** button to select **Fine**.

5. Adjust the **VOLTS/DIV** knob to set the waveform amplitude to exactly five divisions.
6. Use the **VERTICAL POSITION** knob to center the waveform; position the baseline of the waveform 2.5 divisions below the center graticule.
7. Push the **CURSOR** button to see the Cursor menu.
8. Push the top menu box button to set the type to **Time**.
9. Use the **CURSOR 1** knob to place the cursor at the point where the waveform crosses the second graticule line below center screen. This is the 10% point on the waveform.
10. Use the **CURSOR 2** knob to place the second cursor at the point where the waveform crosses the second graticule line above center screen. This is the 90% point on the waveform.
11. The delta readout in the cursor menu is the rise time of the waveform.

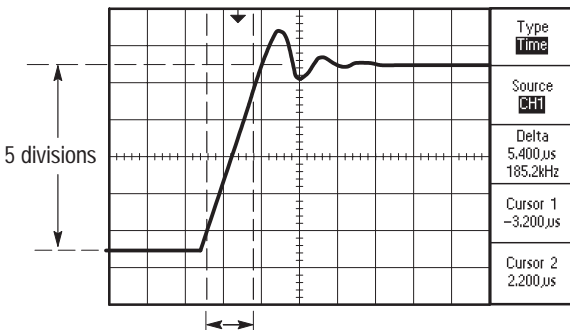

NOTE. The TDS2MM extension module provides rise time as an automatic measurement.

Measuring Ring Frequency

To measure the ring frequency at the rising edge of a signal, do these steps:

1. Push the **CURSOR** button to see the Cursor menu.
2. Push the top menu box button to select **Time**.
3. Use the **CURSOR 1** knob to place a cursor on the first peak of the ring.
4. Use the **CURSOR 2** knob to place a cursor on the second peak of the ring.

You can see the delta time and frequency (the measured ring frequency) in the Cursor menu.

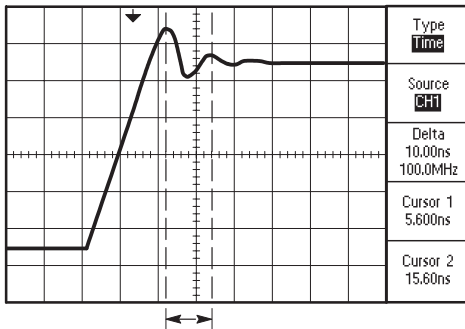

Measuring Ring Amplitude

You measured the ring frequency in the previous example. Now you want to measure the amplitude of the ringing. To measure the amplitude, do these steps:

1. Push the **CURSOR** button to see the Cursor menu.
2. Push the top menu box button to select **Voltage**.
3. Use the **CURSOR 1** knob to place a cursor on the highest peak of the ring.
4. Use the **CURSOR 2** knob to place a cursor on the lowest point of the ring.

You can see the following measurements in the cursor menu:

- The delta voltage (peak-to-peak voltage of the ringing)
- The voltage at Cursor 1
- The voltage at Cursor 2

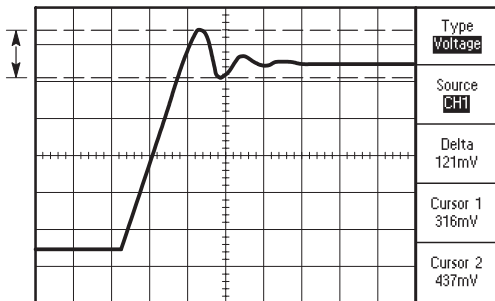

Analyzing Signal Detail

You have a noisy signal displayed on the oscilloscope and you need to know more about it. You suspect that the signal contains much more detail than you can now see in the display.

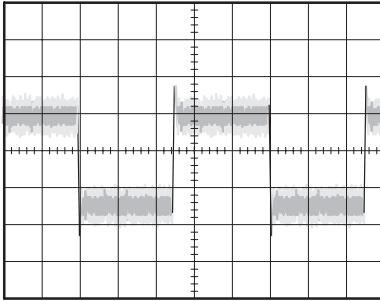

Looking at a Noisy Signal

The signal appears noisy and you suspect that noise is causing problems in your circuit. To better analyze the noise, do these steps:

1. Push the **ACQUIRE** button to see the Acquire menu.
2. Push the **Peak detect** button.
3. If necessary, push the **DISPLAY** button to see the Display menu. Use the **Contrast Increase** and **Contrast Decrease** menu box buttons to adjust the contrast to see the noise more easily.

Peak detect emphasizes noise spikes and glitches in your signal, especially when the time base is set to a slow setting.

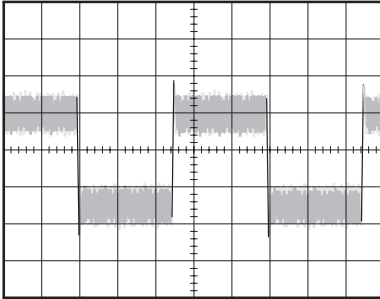

Separating the Signal from Noise

Now you want to analyze the signal shape and ignore the noise. To reduce random noise in the oscilloscope display, do these steps:

1. Push the **ACQUIRE** button to see the Acquire menu.
2. Push the **Average** menu box button.
3. Push the **Averages** menu box button to see the effects of varying the number of running averages on the waveform display.

Averaging reduces random noise and makes it easier to see detail in a signal. In the example below, a ring shows on the rising and falling edges of the signal when the noise is removed.

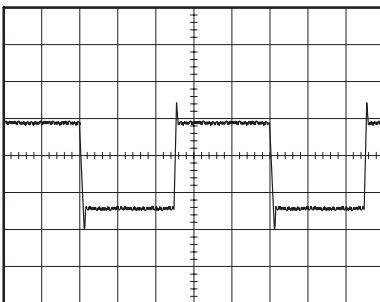

Capturing a Single-Shot Signal

The reliability of a reed relay in a piece of equipment has been poor and you need to investigate the problem. You suspect that the relay contacts arc when the relay opens. The fastest you can open and close the relay is about once per minute so you need to capture the voltage across the relay as a single-shot acquisition.

To set up for a single-shot acquisition, do these steps:

1. Adjust the vertical **VOLTS/DIV** and horizontal **SEC/DIV** to appropriate ranges for the signal you expect to see.
2. Push the **ACQUIRE** button to see the Acquire menu.
3. Push the **Peak detect** button.
4. Push the **TRIGGER MENU** button to see the Trigger menu.
5. Push the **Mode** button to select **Single** (single sequence).
6. Push the **Slope** button to select **Rising**.
7. Use the **LEVEL** knob to adjust the trigger level to a voltage midway between the open and closed voltages of the relay.
8. If the readout at the top of the screen does not display Armed or Ready, then push the **RUN/STOP** button to start the acquisition.

When the relay opens, the oscilloscope is triggered and captures the event.

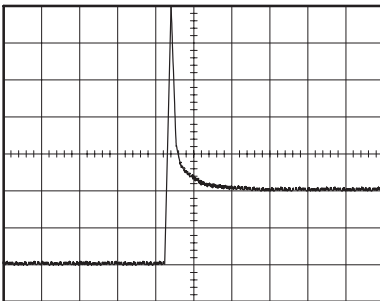

Optimizing the Acquisition

The initial acquisition shows the relay contact beginning to open at the trigger point. This is followed by a large spike that indicates contact bounce and inductance in the circuit. The inductance can cause contact arcing and premature relay failure.

You can adjust the vertical, horizontal, and trigger controls to optimize the settings before the next single-shot event is captured.

When the next acquisition is captured with the new settings, you can see more detail about the relay contact opening. You can now see that the contact bounces several times as it opens.

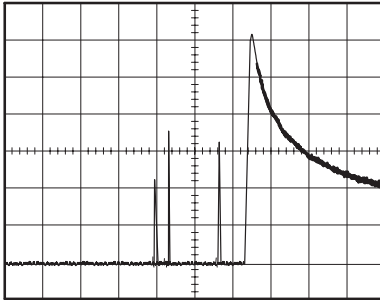

Measuring Propagation Delay

You suspect that the memory timing in a microprocessor circuit is marginal. Set up the oscilloscope to measure the propagation delay between the chip-select signal and the data output of the memory device.

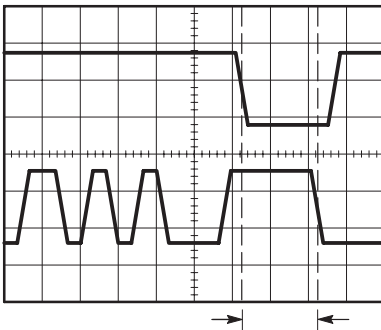
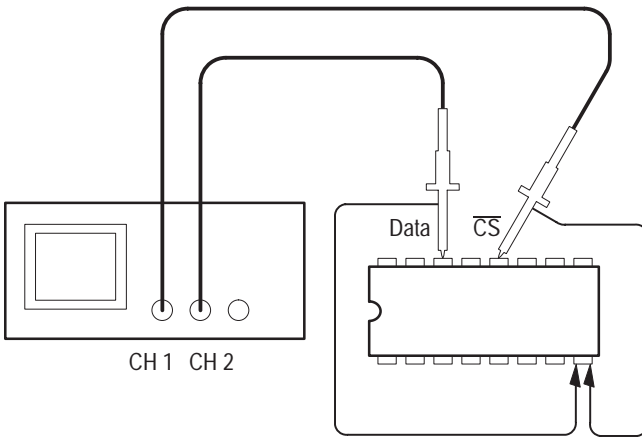

To set up to measure propagation delay, do these steps:

1. If the channels are not displayed, push the **CH 1 MENU** and then **CH 2 MENU** buttons.
2. Push **AUTOSET** to trigger a stable display.
3. Adjust the horizontal and vertical controls to optimize the display.
4. Push the **CURSOR** button to see the Cursor menu.
5. Push the top menu box button to select **Time**.
6. Push the **Source** menu box button to select **CH1**.
7. Use the **CURSOR 1** knob to place the cursor on the active edge of the chip-select signal.
8. Use the **CURSOR 2** knob to place the second cursor on the data output transition.
9. Read the propagation delay in the Delta readout in the cursor menu.

Triggering on a Video Signal

You are testing the video circuit in a piece of medical equipment and need to display the video output signal. The video output is an NTSC standard signal. Use the video trigger to obtain a stable display.

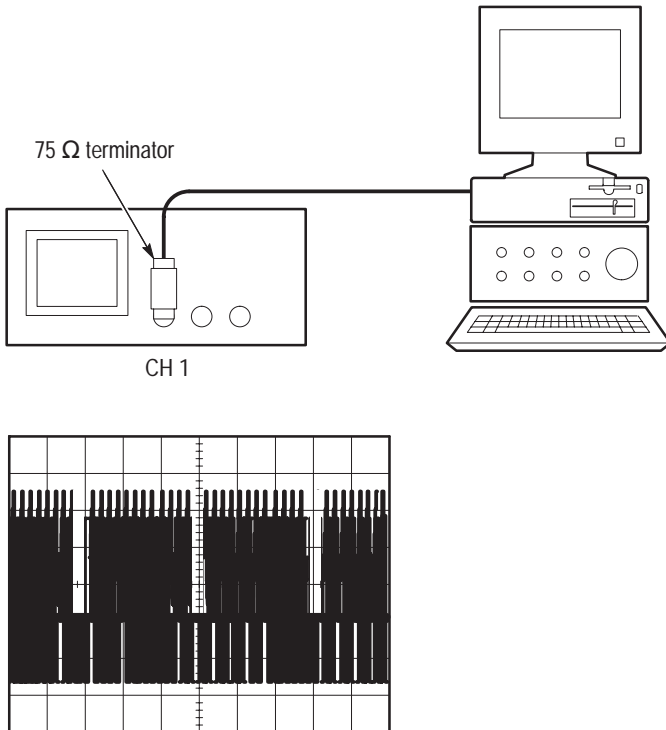

Triggering on Video Fields

To trigger on the video fields, do these steps:

1. Push the **TRIGGER MENU** button to see the Trigger menu.
2. Push the top menu box button to select **Video**.
3. Push the **Sync** menu box button to select **Field**.
4. Adjust the horizontal **SEC/DIV** knob to see a complete field across the screen.
5. Push the **HORIZONTAL MENU** button to see the Main menu.
6. Push the **Trig knob** menu box button to select **Holdoff**.
7. Adjust the **HOLDOFF** knob to an appropriate period. You can use about 21 ms for NTSC (and PAL) video.

Triggering on Video Lines

You can also look at the video lines in the field. To trigger on the lines, do these steps:

1. Push the **TRIGGER MENU** button to see the Trigger menu.
2. Push the top menu box button to select **Video**.
3. Push the **Sync** menu box button to select **Line**.
4. Adjust the horizontal **SEC/DIV** knob to see a complete video line across the screen.

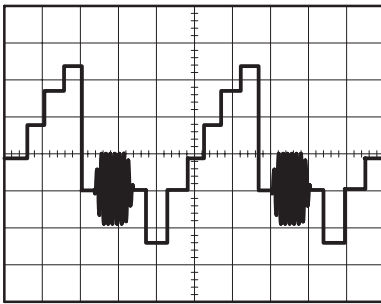
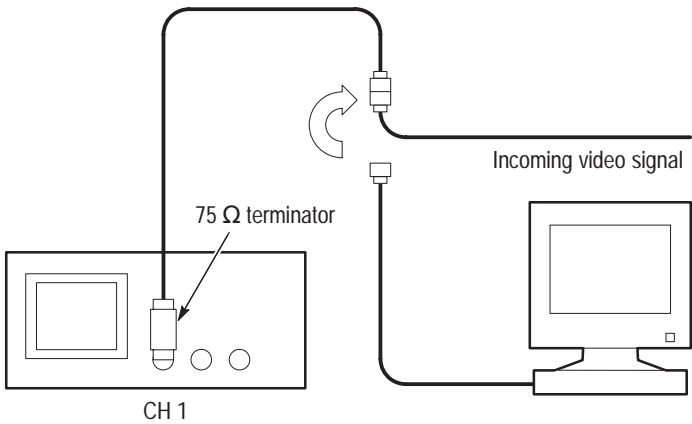

Using the Window Function to See Waveform Details

You can use the window function to examine a specific portion of a waveform without changing the main display.

If you want to view the color burst in the previous waveform in more detail without changing the main display, do these steps:

1. Push the **HORIZONTAL MENU** button to see the Horizontal menu and select **Main**.
2. Adjust the horizontal **SEC/DIV** knob to select 50 ms.
3. Push the **Trig knob** menu box button to select **Holdoff**.
4. Adjust the **HOLDOFF** knob to 61 ms.
5. Adjust the horizontal **SEC/DIV** knob until you see a whole line.
6. Push the **Window Zone** menu box button.
7. Adjust the **SEC/DIV** knob to set the width of the window (area to be expanded).
8. Adjust the **HORIZONTAL POSITION** knob to position the window around the portion of the waveform you want to expand.

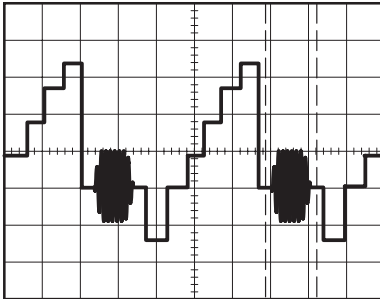

9. Push the **Window** button to see the expanded portion of the waveform.
10. Adjust the **SEC/DIV** knob to optimize viewing the expanded waveform.

To switch between the Main and Window views, push the **Main** or **Window** menu box button in the HORIZONTAL MENU.

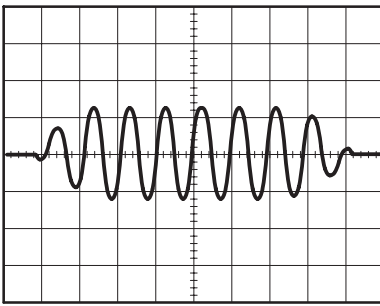

Triggering on Odd or Even Video Fields

Your oscilloscope will trigger on both odd and even video fields, and make the data difficult to view because the line details are a half line apart. To remedy this, you can set the holdoff period to lock on just the odd or even field, which produces a stable display.

For example, the field rate for NTSC video is 60 Hz. For stable triggering, you should set the holdoff period to at least the field rate (16.7 ms), but not to more than twice the field rate (33 ms).

To trigger on only an odd or even video field, do these steps:

1. If channel 1 is not displayed, push the **CH 1 MENU** button.
2. Use the **VERTICAL POSITION** knob to place the waveform on the middle graticule line (position 0).
3. Adjust the **VERTICAL VOLTS/DIV** knob to 500 mV.
4. Push the **Coupling** menu box button to select **DC**.
5. Push the **Probe** menu box button to select **1X**.
6. Push the **TRIGGER MENU** button to see the Trigger menu.
7. Push the top menu box button to select **VIDEO**.
8. Push the **Polarity** menu box button to select **Normal**.
9. Push the **Source** menu box button to select **CH1**.
10. Push the **Sync** menu box button to select **Field**.
11. Push the **ACQUIRE** button to see the Acquire menu.
12. Set SEC/DIV to 10 μ s.
13. Adjust the **HORIZONTAL POSITION** knob to about 1.5 ms.
14. Push the **HORIZONTAL MENU** button to see the Main menu.

15. Push the **Trig knob** menu box button to select **Holdoff**.
16. Adjust the **HOLDOFF** knob to 21 ms for NTSC and PAL video.

***NOTE.** To make a large adjustment to the holdoff period, adjust the **SEC/DIV** knob to 50 ms, adjust the **HOLDOFF** knob to 21 ms, and readjust the **SEC/DIV** back to the previous value.*

Now the oscilloscope only triggers on an odd or an even field (but not both), and the line information is stable.

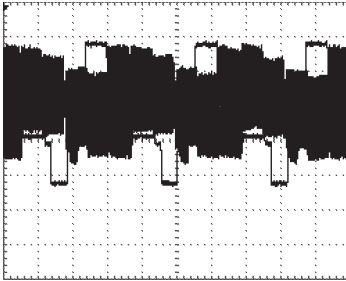

With 500 ns of holdoff time, you cannot see any line information because the alternating fields overlap

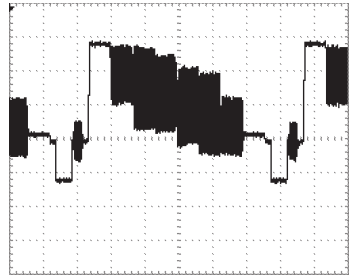

With 21 ms of holdoff time you can easily see one clear line

Analyzing a Differential Communication Signal

You are having intermittent problems with a serial data communication link, and you suspect poor signal quality. Set up the oscilloscope to show you a snapshot of the serial data stream so you can verify the signal levels and transition times.

Because this is a differential signal, you use the math function of the oscilloscope to view a better representation of the waveform.

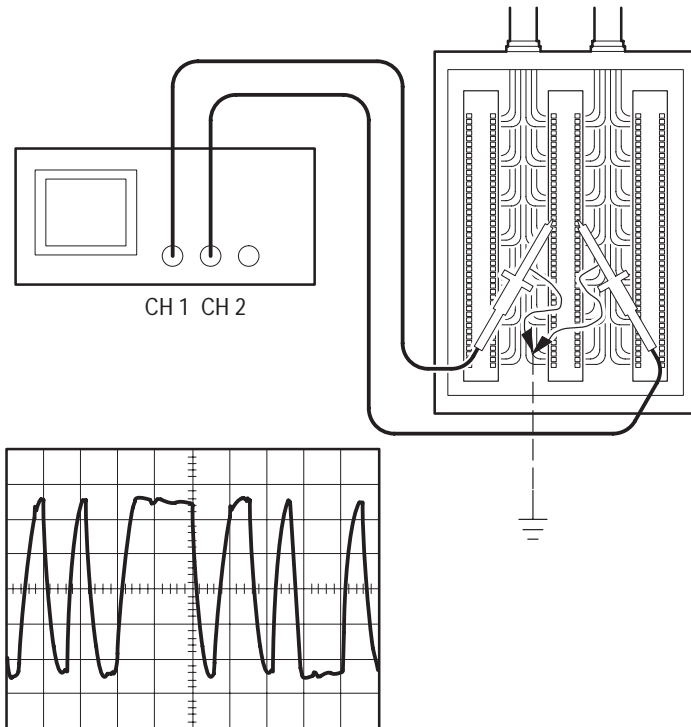

To activate the differential signals connected to channel 1 and channel 2, do these steps:

1. Set the Probe menu attenuation to 10X. Set the switch to 10X on the P2100 probes.
2. If the channels are not displayed, push the **CH 1 MENU** and then **CH 2 MENU** buttons.
3. Push the **AUTOSET** button.
4. Push the **MATH** button to see the Math menu.

TDS 210 and TDS 220 (Firmware V 2.00 and Above), and TDS 224 (All Versions) Oscilloscopes

Do these steps:

1. Push the **Operation** menu box button to select **–**.
2. Push the **CH1–CH2** menu box button to display a new waveform that is the difference between the displayed waveforms.

For a more stable display, use the Run/Stop button to control the acquisition of the waveform. Each time you push the Run/Stop button, the instrument acquires a snapshot of the digital data stream. You can use the cursors or automatic measurements to analyze the waveform, or you can store the waveform to analyze later.

NOTE. *Vertical sensitivity should match on waveforms used for math operations. If they do not match, and you use cursors to measure the waveform result, an U displays that represents unknown in the level and delta readouts.*

TDS 210 and TDS 220 Oscilloscopes (Firmware Below V 2.00) without a TDS2MM

Press the **CH1–CH2** menu box button to display a new waveform that is the difference between the displayed waveforms.

TDS 210 and TDS 220 Oscilloscopes (Firmware Below V 2.00) with a TDS2MM

Do these steps:

1. Push the **CH2 MENU** button and then push the **CH2 Inverted** menu box button to invert the signal on channel 2.
2. Push the **MATH MENU** button and then push the **CH1+CH2** menu box button to display a new waveform that is the difference between the displayed waveforms.

Viewing Impedance Changes in a Network

You have designed a circuit that needs to operate over a wide temperature range. You need to evaluate the change in impedance of the circuit as the ambient temperature is changed.

Connect the oscilloscope to monitor the input and output of the circuit and capture the changes that occur as you vary the temperature.

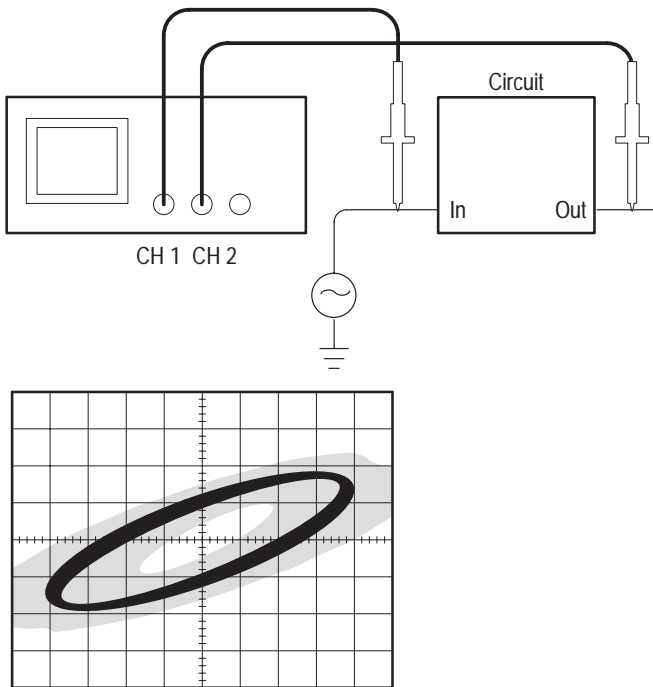

To view the input and output of the circuit in an x-y display, do these steps:

1. Set the Probe menu attenuation to 10X. Set the switch to 10X on the P2100 probes.
2. Connect the channel 1 probe to the input of the network, and connect the channel 2 probe to the output.
3. If the channels are not displayed, push the **CH 1 MENU** and **CH 2 MENU** buttons.
4. Push the **AUTOSET** button.
5. Adjust the **VOLTS/DIV** knobs to display approximately the same amplitude signals on each channel.
6. Push the **DISPLAY** button to see the Display menu.
7. Push the **Format** menu box button to select **XY**.

The oscilloscope displays a Lissajous pattern representing the input and output characteristics of the circuit.

8. Adjust the **VOLTS/DIV** and **VERTICAL POSITION** knobs to display a desirable waveform.
9. Push the **Persist** menu box button to select **Infinite**.
10. Push the **Contrast Increase** or **Decrease** menu box buttons to adjust the contrast of the display for optimal viewing.

As you adjust the ambient temperature, the display persistence captures the changes in the characteristics of the circuit.

Reference

This section describes the menus and operating details associated with each front-panel menu button.

Reference Topic	Page
Acquire	66
Autoset	70
Cursor	71
Display	72
Hard copy	90
Horizontal controls	74
Math	76
Measure	79
Save/Recall	81
Trigger controls	83
Utility	87
Vertical controls	89

Acquire

Push the ACQUIRE button to set acquisition parameters.

Menus	Settings	Comments
Sample		This is the default mode
Peak Detect		Use to detect glitches and reduce the possibility of aliasing
Average		Use to reduce random or uncorrelated noise in the signal display. The number of averages is selectable.
Averages	4 16 64 128	Select Number of Averages

Key Points

If you probe a noisy square wave signal that contains intermittent, narrow glitches, the waveform displayed will vary depending on the acquisition mode you choose.

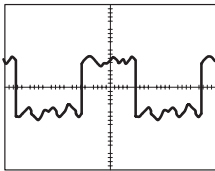

Sample

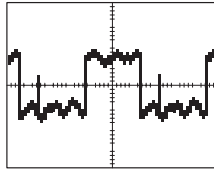

Peak Detect

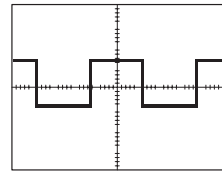

Average

The next two topics describe each of the types of acquisition modes and their differences.

Sample. Use Sample acquisition mode to acquire 2,500 points and display them at the SEC/DIV setting. Sample mode is the default mode.

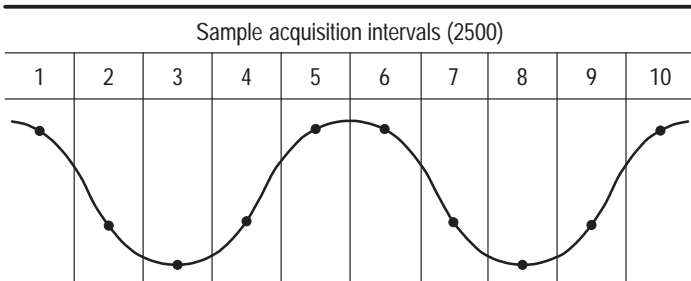

- Sample points

Sample mode acquires a single sample point in each interval.

The maximum sample rate is 1 GS/s. At 100 ns and faster settings, this sample rate does not acquire 2,500 points. In this case, a Digital Signal Processor interpolates points between the sampled points to make a full 2,500 point waveform record.

Peak Detect. Use Peak Detect acquisition mode to detect glitches as narrow as 10 ns and to limit the possibility of aliasing. This mode is effective when at 5 μ s/div or slower.

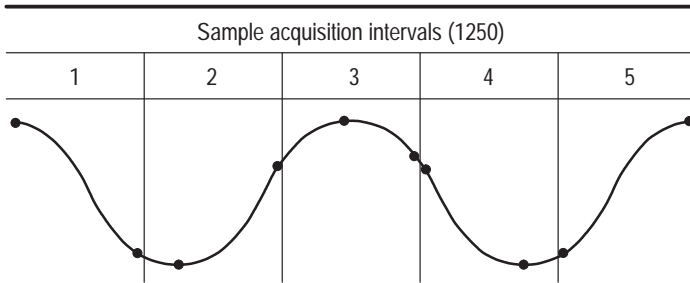

- Sample points displayed

Peak Detect mode displays highest and lowest acquired voltage in each interval.

NOTE. If you set the SEC/DIV to $2.5 \mu\text{s}/\text{div}$ or faster, the acquisition mode changes to Sample because the sample rate is fast enough that you do not need to use Peak Detect. No message displays to tell you that the mode was changed from Peak Detect to Sample.

When there is enough waveform noise, a typical peak detect display shows large black areas. The TDS 200-series oscilloscopes displays this area with diagonal lines to improve display performance.



Typical peak detect display

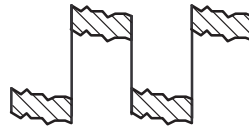

TDS 200 peak detect display

Average. Use Average acquisition mode to reduce random or uncorrelated noise in the signal you want to display. Data is acquired in sample mode, then a number of waveforms are averaged together.

Select the number of acquisitions (4, 16, 64, or 128) to average for the waveform.

Scan Mode Display. When the SEC/DIV control is set to 100 ms/div or slower and the trigger mode set to Auto, the instrument enters the scan acquisition mode. In this mode, the waveform display updates from left to right. There is no horizontal position or trigger control of waveforms during scan mode.

Stopping the Acquisition. While acquisition is running, the waveform display is live. Stopping the acquisition freezes the display. In either mode, the waveform display can be scaled or positioned with the vertical and horizontal controls.

Autoset

The Autoset feature automatically adjusts the controls to produce a usable display of the input signal.

Pushing AUTOSSET adjusts or sets each of the following items listed.

Function	Setting
Acquire mode	Adjusted to Sample or Peak Detect
Vertical coupling	DC (if GND was selected)
Vertical VOLTS/DIV	Adjusted
Bandwidth	Full
Horizontal position	Centered
Horizontal SEC/DIV	Adjusted
Trigger type	Edge
Trigger source	Lowest numbered channel displayed
Trigger coupling	Adjusted to DC, Noise Reject, or HF Reject
Trigger slope	Rising
Trigger holdoff	Minimum
Trigger level	Set to 50%
Display format	YT
Trigger mode	Auto

Cursors

Push the CURSOR button to display the measurement cursors and cursor menu.

Menu	Settings	Comments
Type	Voltage Time Off	Select and display the measurement cursors; Voltage measures amplitude and Time measures time and frequency
Source	CH1 CH2 CH3* CH4* MATH REFA REFB REFC* REFD*	Choose the waveform on which to take the cursor measurement The readouts display this measurement.
Delta		The difference (delta) between the cursors is displayed here
Cursor 1		Displays cursor 1 location (time is referenced to the trigger position, voltage is referenced to ground)
Cursor 2		Displays cursor 2 location (time is referenced to the trigger position, voltage is referenced to ground)

* Only available on the TDS 224 oscilloscope.

Key Points

Cursor Movement. Use the CH 1 and CH 2 Vertical Position knobs to move cursors 1 and 2. You can move the cursors only while the Cursor menu is displayed.

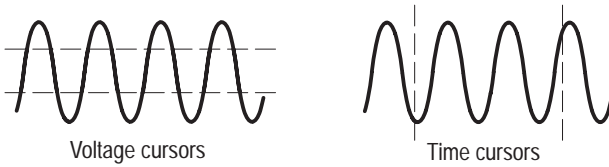

U in Level and Delta Readouts. Vertical sensitivity should match on waveforms used for math operations. If they do not match, and you use cursors to measure the waveform result of a math operation, an U displays that represents unknown.

Display

Push the DISPLAY button to choose how waveforms are presented and to change the appearance of the entire display.

Menu	Settings	Comments
Type	Vectors Dots	Vectors fills the space between adjacent sample points in the display Dots displays only the sample points
Persist	OFF 1 sec 2 sec 5 sec Infinite	Sets the length of time each displayed sample point remains displayed
Format	YT XY	YT format displays the vertical voltage in relation to time (horizontal scale) XY format displays channel 1 in the horizontal axis and channel 2 in the vertical axis
Contrast Increase		Darkens the black (or gray) areas of the display
Contrast Decrease		Lightens the white areas of the display

Key Points

Persistence. When using persistence, old data retained is displayed in gray while the new data is black.

With Persistence set to Infinite, record points accumulate until a control is changed.

XY Format. This format only applies to channels 1 and 2. Choose XY display format to display channel 1 in the horizontal axis and channel 2 in the vertical axis. The oscilloscope uses the untriggered sample acquisition mode and data displays as dots. The sampling rate is 1 MS/s and can not be changed.

NOTE. *The oscilloscope can capture a waveform in normal YT mode at any sampling rate. You can view the same waveform in XY mode. To do so, stop the acquisition and change the display format to XY.*

The controls operate as follows:

- The channel 1 VOLTS/DIV and vertical POSITION controls set the horizontal scale and position.
- The channel 2 VOLTS/DIV and vertical POSITION controls continue to set vertical scale and position.

The following functions do not work in XY display format:

- Ref or Math waveforms
- Cursors
- Autoset (resets display format to YT)
- Time base controls
- Trigger controls

Horizontal

You can use the horizontal controls to change the horizontal scale and position of waveforms. The horizontal center of the screen is the time reference for waveforms. Changing the horizontal scale causes the waveform to expand or contract around the screen center.

Horizontal position changes the point, relative to the trigger, where the waveform appears on the center of the screen.

Menu	Settings	Comments
Main		The main horizontal time base setting is used to display the waveform
Window Zone		Two cursors define a window zone Adjust the window zone with the Horizontal Position and SEC/DIV controls
Window		Changes the display to show the waveform segment (expanded to screen width) within the window zone
Trig knob	Level Holdoff	Selects whether the Trigger Level knob adjusts the trigger level (volts) or holdoff time (sec) The holdoff value is displayed

NOTE. You can push the Window menu box button to switch between an entire waveform display and an enlarged, more detailed part of it.

Key Points

SEC/DIV. If waveform acquisition is stopped (using the RUN/STOP button), the SEC/DIV control expands or compresses the waveform.

Scan Mode Display. When the SEC/DIV control is set to 100 ms/div or slower and the trigger mode is set to Auto, the instrument enters the scan acquisition mode. In this mode, the waveform display updates from left to right. There is no trigger or horizontal control of waveforms during scan mode.

Window Zone. Use the window zone to expand a segment of a waveform to see more detail. The Window time base setting cannot be set slower than the Main time base setting.

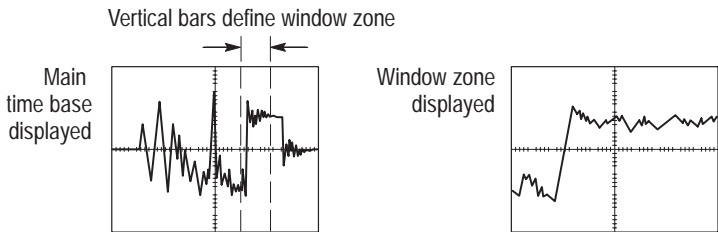

Holdoff. Use holdoff to help stabilize the display of nonperiodic waveforms.

Holdoff begins when the instrument recognizes a trigger event and disables the trigger system until acquisition is complete. The trigger system remains disabled during the holdoff time that follows each recognized trigger event.

Math

Although you access the Math menu in the same way, the menu boxes vary, depending on the oscilloscope model, firmware version, and installed module.

Push the MATH MENU button to display the waveform math operations. Push the MATH MENU button again to turn off the math waveform display. Refer to page 89 for vertical system descriptions.

The following tables list menu boxes available based on the oscilloscope model, firmware version, and installed module.

TDS 210 and TDS 220 (Firmware V 2.00 and Above), and TDS 224 (All Versions) Oscilloscopes

Operation menu	Menu	Settings	Comments
– (subtraction)	CH1 – CH2		The channel 2 waveform is subtracted from the channel 1 waveform
	CH2 – CH1		The channel 1 waveform is subtracted from the channel 2 waveform
	CH3 – CH4*		The channel 4 waveform is subtracted from the channel 3 waveform
	CH4 – CH3*		The channel 3 waveform is subtracted from the channel 4 waveform
+ (addition)	CH1 + CH2		Channels 1 and 2 are added together
	CH3 + CH4*		Channels 3 and 4 are added together

* Only available on the TDS 224 oscilloscope.

NOTE. The optional TDS2MM measurement extension module adds the FFT feature to the oscilloscope. See the TDS 200-Series Extension Modules Instructions Manual.

TDS 210 and TDS 220 Oscilloscopes (Firmware Below V 2.00) without a TDS2MM

Menu	Settings	Comments
CH1 – CH2		The channel 2 waveform is subtracted from the channel 1 waveform
CH2 – CH1		The channel 1 waveform is subtracted from the channel 2 waveform
CH1 + CH2		Channels 1 and 2 are added together
CH1 Inverted		The channel 1 signal display is inverted (cannot be inverted if channel 2 is inverted)
CH2 Inverted		The channel 2 signal display is inverted (cannot be inverted if channel 1 is inverted)

TDS 210 and TDS 220 Oscilloscopes (Firmware Below V 2.00) with a TDS2MM

The TDS2MM Module when used with a TDS 210 or TDS 220 changes the following math operations:

- The TDS2MM Module does not have the CH1–CH2 and CH2–CH1 math functions. To do the same functions, invert the channel you want to subtract (using the CH1 or CH2 menu) and then select the CH1+CH2 math function.

Default channel subtraction	TDS2MM channel subtraction	Comments
CH1-CH2	CH1+(-CH2)	(-CH2) means invert channel 2
CH2-CH1	(-CH1)+CH2	(-CH1) means invert channel 1

- The TDS2MM Module moves the channel invert function from the MATH menu to the Vertical CH1 and CH2 menus.

Key Points

VOLTS/DIV. Use the VOLTS/DIV control to scale the waveforms of the channels. The math waveform is the visual sum or difference of the channel waveforms.

Channel Display for a TDS 210 or TDS 220 (Firmware Below V 2.00).

Displaying a math waveform automatically removes the display of channels used to create the math waveform. Math operations are turned off if a channel used in the operation is turned on.

NOTE. *You can push the menu box button of the enabled math operation on a TDS 210 or TDS 220 to switch between the math waveform and the channels used to create the math waveform.*

Math Operations. Only one math operation is allowed. Using the subtraction selection eliminates the need to first invert and then add the waveform for subtraction operations.

Measure

Push the MEASURE button to access the automated measurement capabilities. There are five measurements available and the ability to display up to four at a time.

Press the top menu button to display the Source or the Type menu. You can choose the channel on which to take a measurement in the Source menu. You can choose the type of measurement to take (Freq, Period, Mean, Pk–Pk, Cyc RMS, and None) in the Type menu.

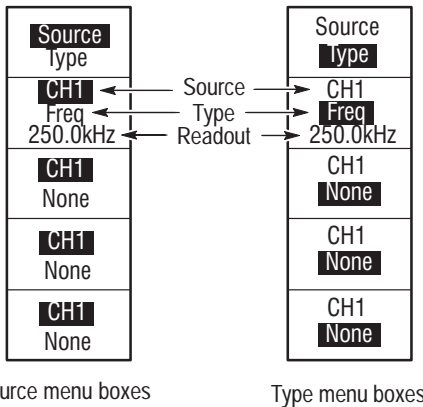

NOTE. The optional TDS2MM measurement extension module adds the rise time, fall time, positive pulse width, and negative pulse width measurements to the oscilloscope. See the TDS 200-Series Extension Modules Instructions Manual.

Key Points

Taking Measurements. You can display up to four automated measurements at a time for a single waveform (or divided among the waveforms). The waveform channel must be on (displayed) to make a measurement.

Automated measurements cannot be taken on reference or math waveforms or while using XY or scan mode.

Measurement Type	Definition
Cyc RMS	Calculates a true RMS measurement of one complete cycle of the waveform
Mean	Calculates the arithmetic mean voltage over the entire record
Period	Calculates the time for one cycle
Pk-Pk	Calculates the absolute difference between the maximum and minimum peaks of the entire waveform
Freq	Calculates the frequency of the waveform by measuring the first cycle

Save/Recall

Push the SAVE/RECALL button to save or recall instrument setups or waveforms.

Setups

Menu	Settings	Comments
Setups		Highlighting Setups displays the menus for storing or recalling instrument setups
Recall Factory		Sets the instrument controls to the default factory settings
Setup	1 2 3 4 5	Specifies the memory location in which to save the current instrument settings or from which to recall the settings
Save		Completes the save action
Recall		Recalls the instrument settings stored in the location chosen in the Setup field

Key Points

Saving and Recalling Setups. The complete setup is stored in nonvolatile memory. When you recall the setup, you will be in the mode from which the setup was saved.

When turning the instrument on, all settings return to the settings that were in place when the instrument was turned off.

Recalling the Factory (Default) Setup. You can recall the default Factory Setup to initialize the instrument to a known setup.

Waveforms

Menu	Settings	Comments
Waveforms		Highlighting Waveforms displays the menus for storing or recalling waveforms
Source	CH1 CH2 CH3* CH4* Math	Choose the waveform display to store
Ref	A B C* D*	Choose the reference location to store or recall a waveform
Save		Stores source waveform to the chosen reference location
Ref(x)	ON OFF	Turns the reference waveform display on or off

* Only available on the TDS 224 oscilloscope.

Saving and Recalling Waveforms. For the TDS 210 and TDS 220 oscilloscopes, you can store two reference waveforms in nonvolatile memory. For the TDS 224 oscilloscope, you can store four reference waveforms, although you can only display two at a time. You can display reference waveforms simultaneously with current waveform acquisitions.

Recalled waveforms are not adjustable.

Trigger Controls

Two types of triggering are available: Edge and Video. A different set of menus display for each trigger type.

Edge Trigger

Use Edge triggering to trigger on the edge of the input signal at the trigger threshold.

Menu	Settings	Comments
Edge		With Edge highlighted, the rising or falling edge of the input signal is used for the trigger
Slope	Rising Falling	Select to trigger on either the rising or falling edge of the signal
Source	CH1 CH2 CH3* CH4* EXT** EXT/5** AC Line	Select the input source as the trigger signal
Mode	Auto Normal Single	Select the type of triggering
Coupling	AC DC Noise Reject HF Reject LF Reject	Selects the components of the trigger signal applied to the trigger circuitry

* Only available on the TDS 224 oscilloscope.

** Only available on the TDS 210 and TDS 220 oscilloscopes.

Key Points

Normal and Auto Mode. Use Normal trigger mode to trigger only on a valid trigger. Use Auto trigger mode to let the acquisition free-run in the absence of a valid trigger. Auto allows an untriggered, scanning waveform at 100 ms/div or slower time base settings.

Single Mode. Use Single trigger mode to capture a single acquisition of an event. The content of a single acquisition sequence depends on the acquisition mode.

Acquisition Mode	Single Acquisition Sequence
Sample or Peak Detect	Sequence is complete when one acquisition is acquired
Average	Sequence is complete when the defined number of acquisitions is reached (refer to page 66)

EXT and EXT/5 Source (TDS 210 and TDS 220 Only). The EXT trigger source uses the signal connected to the EXT TRIG connector. The EXT/5 trigger source uses the signal connected to the EXT TRIG connector and divides it by 5; this extends the trigger level range.

AC Line Source. The AC Line trigger source uses the power signal as the trigger source. Trigger coupling is set to DC and the trigger level to 0 volts.

Coupling. Coupling allows you to filter the trigger signal used to trigger an acquisition.

- DC passes all components of the signal.
- AC blocks DC components and attenuates signals below 10 Hz.
- Noise Reject passes all components of the signal but increases the peak-to-peak signal required.
- HF Reject attenuates the high-frequency components above 80 kHz.
- LF Reject blocks the DC component and attenuates the low-frequency components below 300 kHz.

Pretrigger. The trigger position is typically set at the horizontal center of the screen. In this case you are able to view five divisions of pretrigger information. Adjusting the Horizontal Position of the waveform allows you to see more or less pretrigger information.

Trigger View. Pushing TRIGGER VIEW displays the trigger waveform until the button is released.

When in Trigger View mode, all front-panel buttons are disabled except HARDCOPY.

Video Trigger

Choose video triggering to trigger on fields or the lines of an NTSC, PAL, or SECAM standard video signal.

Menu	Settings	Comments
Video		With Video highlighted, triggering occurs on an NTSC, PAL, or SECAM standard video signal Trigger coupling is preset to AC
Polarity	Normal Inverted	Normal triggers on the negative edge of the sync pulse and Inverted triggers on the positive edge of the sync pulse
Source	CH1 CH2 CH3* CH4* EXT** EXT/5**	Selects the input source as the trigger signal EXT and EXT/5 use the signal applied to the EXT TRIG connector as the source
Sync	Field Line	Select to trigger on fields or lines

* Only available on the TDS 224 oscilloscope.

** Only available on the TDS 210 and TDS 220 oscilloscopes.

Key Points

Sync Pulses. When you choose Normal Polarity, the trigger always occurs on negative-going sync pulses. If your video signal has positive-going sync pulses, use the Inverted Polarity selection.

Utility

Push the UTILITY button to display the utility menus. The Utility menus change with the addition of extension modules. The menus explained here relate to the product with no modules installed. Refer to the manual supplied with your extension module for items not discussed here.

Menu	Settings	Comments
System Status		Displays the system menus
Do Self Cal		Performs a self calibration
Error Log		Displays a list of any errors logged This list is useful when contacting a Tektronix Service Center for help
Language	English French German Italian Spanish Portuguese Japanese Korean Simplified Chinese Traditional Chinese	Selects the display language of the operating system

Key Points

Self Calibration. The self calibration routine optimizes the oscilloscope accuracy for the ambient temperature. For maximum accuracy, perform a self cal if the ambient temperature changes by 5° C or more.

To compensate the signal path, disconnect any probes or cables from the input connectors. Then, select Do Self Cal to confirm that you are ready to proceed.

System Status

Selecting System Status from the utility menu displays the menus available for obtaining a list of control settings for each group of instrument controls.

Push any front-panel menu button to remove the status screen.

Menu	Settings	Comments
Horizontal		Lists horizontal parameters of channels
Vertical		Lists vertical parameters of channels
Trigger		Lists trigger parameters
Misc		Lists the model of the instrument and the software version number If an extension module is installed, lists values of the communications parameters

Vertical

You can use the vertical controls to display waveforms, adjust vertical scale and position, and set input parameters. Refer to page 76 for the vertical math descriptions.

Channel Vertical Menus

There is a separate vertical menu for each channel. Each item is set individually for each channel.

Menu	Settings	Comments
Coupling	DC AC GND	DC passes both AC and DC components of the input signal AC blocks the DC component of the input signal GND disconnects the input signal
BW Limit	20 MHz* Off	Limits the bandwidth to reduce display noise
Volts/Div	Coarse Fine	Selects the resolution of the Volts/Div knob Coarse defines a 1–2–5 sequence. Fine changes the resolution to small steps between the coarse settings
Probe	1x 10x 100x 1000x	Set this to match your probe attenuation factor to make the vertical scale readout correct
Invert	On Off	Not available on a TDS 210 or TDS 220 (firmware below V 2.00) without a TDS2MM installed

* Bandwidth is not valid for the P2100 probe when the switch is set to 1X.

Key Points

GND Coupling. Use GND coupling to display a zero-volt waveform. When you use GND coupling, the input BNC connector is disconnected from internal circuits. Internally, the channel input is connected to a zero-volt reference level.

Fine Resolution. The vertical scale readout displays the actual Volts/Div setting while in the fine resolution setting. Changing the setting to coarse does not change the vertical scale until the VOLTS/DIV control is adjusted.

U in Level and Delta Readouts. Vertical sensitivity should match on waveforms used for math operations. If they do not match, and you use cursors to measure the waveform result of a math operation, an U displays that represents unknown.

Waveform off. To remove a waveform from the display, push the MENU button for the channel to display its vertical menu. Push the menu button again to turn the waveform off. An input channel can still be used as a trigger source or for math displays while turned off.

Hard Copy

Push the HARDCOPY button to print a hard copy of the display. The hard-copy function requires that an extension module with a Centronics, RS-232, or GPIB port be installed and connected to a printer.

Refer to the manual supplied with your extension module for instructions on connections and using the module.

Refer to *Optional Accessories* on page 103 for information about the available extension modules.

Appendix A: Specifications

All specifications apply to the TDS 200-Series Digital Oscilloscopes and a P2100 probe with the Attenuation switch set to 10X unless noted otherwise. To meet specifications, two conditions must first be met:

- The instrument must have been operating continuously for twenty minutes within the specified operating temperature.
- You must perform the Self Cal operation, accessible through the Utility menu, if the operating temperature changes by more than 5° C.

All specifications are guaranteed unless noted “typical.”

Specifications

Acquisition		
Acquisition Modes	Sample, Peak Detect, and Average	
Acquisition Rate, typical	Up to 180 waveforms per second, per channel (Sample acquisition mode, no measurements)	
Single Sequence	<i>Acquisition Mode</i>	<i>Acquisition Stops After</i>
	Sample, Peak Detect	Single acquisition, all channels simultaneously
	Average	N acquisitions, all channels simultaneously, N is selectable from 4, 16, 64, and 128
Inputs		
Input Coupling	DC, AC, or GND	
Input Impedance, DC Coupled	1 M Ω \pm 2% in parallel with 20 pF \pm 3 pF	

Specifications (Cont.)

P2100 Probe Attenuation	1X, 10X	
Probe Attenuation Factors	1X, 10X, 100X, 1000X	
Maximum Voltage Between Signal and Common at input BNC	<i>Overvoltage Category</i>	<i>Maximum Voltage</i>
	CAT I and CAT II	300 V _{RMS} (420 V peak, duty factor < 50%, pulse width < 100 msec.)
	CAT III	150 V _{RMS}
	For steady-state sinusoidal waveforms, derate at 20 dB/decade above 100 kHz to 13 V _{pk} at 3 MHz* and above. Also, refer to <i>Overvoltage Category</i> description on page 102.	
Maximum Voltage Between Probe Tip and ground using P2100 probe connected to input BNC	<i>Overvoltage Category</i>	<i>Maximum Voltage</i>
	CAT I and CAT II	300 V _{RMS} (500 V peak, duty factor < 35%, pulse width < 100 msec.)
	CAT III	150 V _{RMS}
	Derate at 20 dB/decade above 900 kHz to 13 V _{RMS} at 27 MHz* and above. Also, refer to <i>Overvoltage Category</i> description on page 102.	
Time delay between channels, typical	150 ps	
Channel-to-Channel Common Mode Rejection, typical	<i>TDS 210</i>	<i>TDS 220 and TDS 224</i>
	100:1 at 60 Hz 20:1 at 30 MHz*	100:1 at 60 Hz 20:1 at 50 MHz*
	Measured on MATH Ch1 – Ch2 waveform, with test signal applied between signal and common of both channels, and with the same VOLTS/DIV and coupling settings on each channel. Also measured on MATH Ch3 – Ch4 waveform for the TDS 224.	

* Bandwidth is not valid for the P2100 probe when the switch is set to 1X.

Specifications (Cont.)

Inputs		
Channel-to-Channel Crosstalk	<i>TDS 210</i>	<i>TDS 220 and TDS 224</i>
	≥ 100:1 at 30 MHz*	≥ 100:1 at 50 MHz*
	Measured on one channel, with test signal applied between signal and common of the other channel, and with the same VOLTS/DIV and coupling settings on each channel.	
Vertical		
Digitizers	8-bit resolution (except when set to 2 mV/div), each channel sampled simultaneously	
VOLTS/DIV Range	2 mV/div to 5 V/div at input BNC	
Position Range	2 mV/div to 200 mV/div, ±2 V > 200 mV/div to 5 V/div, ±50 V	
Analog Bandwidth in Sample and Average modes at BNC or with P2100 probe, DC Coupled	<i>TDS 210</i>	<i>TDS 220 and TDS 224</i>
	60 MHz* (when vertical scale set to > 5 mV/div)	100 MHz* (when vertical scale set to > 5 mV/div)
	20 MHz* (when vertical scale set to ≤ 5 mV/div)	
Analog Bandwidth in Peak Detect mode (5 s/div to 5 μs/div**), typical	<i>TDS 210</i>	<i>TDS 220 and TDS 224</i>
	50 MHz* (when vertical scale set to > 10 mV/div)	75 MHz* (when vertical scale set to > 10 mV/div)
	20 MHz* (when vertical scale set to ≤ 10 mV/div)	
Selectable Analog Bandwidth Limit, typical	20 MHz*	
Lower Frequency Limit, AC Coupled	≤ 10 Hz at BNC ≤ 1 Hz when using a 10X passive probe	

* Bandwidth is not valid for the P2100 probe when the switch is set to 1X.

** The oscilloscope reverts to Sample mode when the sec/div (horizontal scale) is set from 2.5 μs/div to 5 ns/div. The Sample mode can still capture 10 ns glitches.

Specifications (Cont.)

Vertical		
Rise Time at BNC, typical	<i>TDS 210</i>	<i>TDS 220 and TDS 224</i>
	< 5.8 ns	< 3.5 ns
Peak Detect Response**	Captures 50% or greater amplitude of pulses ≥ 10 ns wide (5 s/div to 5 μ s/div) in the center 8 vertical divisions	
DC Gain Accuracy	2 mV/div to 5 mV/div, $\pm 4\%$ for Sample or Average acquisition mode	
	10 mV/div and larger, $\pm 3\%$ for Sample or Average acquisition mode	
DC Measurement Accuracy, Average Acquisition Mode	<i>Measurement Type</i>	<i>Accuracy</i>
	Average of ≥ 16 waveforms with vertical position at zero	$\pm(4\% \times \text{reading} + 0.1 \text{ div} + 1 \text{ mV})$
	Average of ≥ 16 waveforms with vertical position not at zero	$\pm[3\% \times (\text{reading} + \text{vertical position}) + 1\% \text{ of vertical position} + 0.2 \text{ div}]$ Add 2 mV for settings from 2 mV/div to 200 mV/div. Add 50 mV for settings from > 200 mV/div to 5 V/div.
Delta Volts Measurement Accuracy, Average Acquisition Mode	Delta volts between any two averages of ≥ 16 waveforms acquired under same setup and ambient conditions	$\pm(3\% \times \text{reading} + 0.05 \text{ div})$

** The oscilloscope reverts to Sample mode when the sec/div (horizontal scale) is set from 2.5 μ s/div to 5 ns/div. The Sample mode can still capture 10 ns glitches.

Specifications (Cont.)

P2100 passive probe	10X position	1X position
Bandwidth	DC to 100 MHz	DC to 7 MHz
Attenuation ratio	10:1	1:1
Compensation Range	18 pf-35 pf	All oscilloscopes with 1 M Ω input
Input resistance	10 M $\Omega \pm 2\%$	1 M $\Omega \pm 2\%$
Input capacitance	14.5 pf-17.5 pf	80 pf-110 pf
Maximum input voltage	10X position	300 V RMS CAT I or 300 V DC CAT I 300 V RMS CAT II or 300 V DC CAT II 100 V RMS CAT III or 100 V DC CAT III
	1X position	150 V RMS CAT I or 150 V DC CAT I 150 V RMS CAT II or 150 V DC CAT II 100 V RMS CAT III or 100 V DC CAT III

Specifications (Cont.)

Horizontal		
Sample Rate Range	50 S/s to 1 GS/s	
Waveform Interpolation	(sin x)/x	
Record Length	2500 samples for each channel	
SEC/DIV Range	5 ns/div to 5 s/div, in a 1, 2.5, 5 sequence	
Sample Rate and Delay Time Accuracy	±100 ppm over any ≥1 ms time interval	
Delta Time Measurement Accuracy (Full Bandwidth)	<i>Conditions</i>	<i>Accuracy</i>
	Single-shot, Sample mode	±(1 sample interval + 100 ppm × reading + 0.6 ns)
	> 16 averages	±(1 sample interval + 100 ppm × reading + 0.4 ns)
	Sample interval = s/div ÷ 250	
Position Range	5 ns/div to 10 ns/div	(-4 div × s/div) to 20 ms
	25 ns/div to 100 μs/div	(-4 div × s/div) to 50 ms
	250 μs/div to 5 s/div	(-4 div × s/div) to 50 s

Specifications (Cont.)

Trigger			
Trigger Sensitivity, Edge Trigger Type	<i>Coupling</i>	<i>Sensitivity</i>	
	DC	CH 1, CH 2, CH 3 & CH 4	1 div from DC to 10 MHz*, 1.5 div from 10 MHz* to Full
		<i>TDS 210 and TDS 220 only</i>	
		EXT	100 mV from DC to 10 MHz*, 150 mV from 10 MHz* to Full
EXT/5	500 mV from DC to 10 MHz*, 750 mV from 10 MHz* to Full		
Trigger Sensitivity, Edge Trigger Type, typical	<i>Coupling</i>	<i>Sensitivity</i>	
	AC	Same as DC at 50 Hz and above	
	NOISE REJ	Reduces the DC-coupled trigger sensitivity by 2 times for > 10 mv/div to 5 V/div	
	HF REJ	Same as the DC-coupled limit from DC to 7 kHz, attenuates signals above 80 kHz	
	LF REJ	Same as the DC-coupled limits for frequencies above 300 kHz, attenuates signals below 300 kHz	
Trigger Level Range	<i>Source</i>	<i>Range</i>	
	Internal	±8 divisions from center of screen	
	<i>TDS 210 and TDS 220 only</i>		
	EXT	±1.6 V	
	EXT/5	±8 V	

* Bandwidth is not valid for the P2100 probe when the switch is set to 1X.

Specifications (Cont.)

Trigger		
Trigger Level Accuracy, typical	Accuracies are for signals having rise and fall times ≥ 20 ns	
	<i>Source</i> <i>Accuracy</i>	
	Internal $\pm 0.2 \text{ div} \times \text{volts/div}$ within ± 4 divisions from center screen	
	<i>TDS 210 and TDS 220 only</i>	
	EXT $\pm(6\% \text{ of setting} + 40 \text{ mV})$	
	EXT/5 $\pm(6\% \text{ of setting} + 200 \text{ mV})$	
SET LEVEL TO 50%, typical	Operates with input signals ≥ 50 Hz	
Default Settings, Video Trigger	Trigger mode is Auto and Coupling is AC	
Sensitivity, Video Trigger Type, typical	Composite video signal	
	<i>Source</i> <i>Range</i>	
	Internal Pk-pk amplitude of 2 divisions	
	<i>TDS 210 and TDS 220 only</i>	
	EXT 400 mV	
	EXT/5 2 V	
Signal Formats and Field Rates, Video Trigger Type	Supports NTSC, PAL, and SECAM broadcast systems for any field or any line	
Holdoff Range	500 ns to 10 s	
Measurements		
Cursors	Voltage difference between cursors (ΔV)	
	Time difference between cursors (ΔT)	
	Reciprocal of ΔT in Hertz ($1/\Delta T$)	
Automated Measurements	Cycle RMS, Mean, Pk - Pk, Period, Frequency	

General Specifications

Display		
Display Type	5.7 in. (145 mm) diagonal liquid crystal	
Display Resolution	320 horizontal by 240 vertical pixels	
Display Contrast	Adjustable, temperature compensated	
Backlight Intensity, typical	60 cd/m ²	
Probe Compensator Output		
Output Voltage, typical	5 V into $\geq 1 \text{ M}\Omega$ load	
Frequency, typical	1 kHz	
Power Source		
Source Voltage	100 – 120 VAC _{RMS} ($\pm 10\%$) from 45 Hz through 440 Hz, CAT II 120 – 240 VAC _{RMS} ($\pm 10\%$) from 45 Hz through 66 Hz, CAT II	
Power Consumption	<i>TDS 210 and TDS 220</i>	<i>TDS 224</i>
	Less than 20 W	Less than 25 W
Fuse	1 A, T rating, 250 V	
Environmental		
Temperature	Operating	0° C to +50° C
	Nonoperating	-20° C to +60° C
Cooling Method	Convection	
Humidity	+40° C or below	$\leq 90\%$ relative humidity
	+41° C to +50° C	$\leq 60\%$ relative humidity
Altitude	Operating	3,000 m
	Nonoperating	15,000 m

General Specifications (Cont.)

Environmental		
Random Vibration	Operating	0.31 g _{RMS} from 5 Hz to 500 Hz, 10 minutes on each axis
	Nonoperating	2.46 g _{RMS} from 5 Hz to 500 Hz, 10 minutes on each axis
Mechanical Shock	Operating	50 g, 11 ms, half sine
Mechanical		
Size	Height	151.4 mm (5.96 in.)
	Width	304.8 mm (12 in.)
	Depth	120.7 mm (4.75 in.)
Weight (approximate)	When packaged for domestic shipment	3.6 kg (8.0 lbs)

General Specifications (Cont.)

Certifications and Compliances

<p>EC Declaration of Conformity</p> <p>(TDS 210, TDS 220, TDS 224)</p> <p>(TDS 210, TDS 220, TDS 224, P2100)</p> <p>(P2100)</p>	<p>Meets intent of Directive 89/336/EEC for Electromagnetic Compatibility; meets the requirements of FCC Code of Federal Regulations, 47 CFR, Part 15, Subpart B, Class A:</p> <p>CISPR 11 (Class A): Electromagnetic radiated and conducted emissions</p> <p>IEC 1000-3-2 power line harmonics</p> <p>EN 50082-1 European Community Requirements:</p> <p>IEC 61000-4-2 electrostatic discharge</p> <p>IEC 61000-4-3 radiated susceptibility</p> <p>IEC 61000-4-4 power line fast transients</p> <p>IEC 61000-4-5 power line surge immunity</p> <p>IEC 61000-4-6 conducted immunity to RF fields</p> <p>IEC 61000-4-8 magnetic immunity</p> <p>IEC 61000-4-11 voltage dips, interrupts and variations</p> <p>AS/NZS 2064, Australian emissions standard for Industrial, Scientific, and Medical Equipment</p> <p>Low Voltage Directive 73/23/EEC as amended by 93/68/EEC:</p> <p>EN 61010-1/A2:1995 Safety requirements for electrical equipment for measurement, control, and laboratory use</p> <p>EN 61010-2-031:1994 Particular requirements for hand-held probe assemblies for electrical measurement and test</p>
<p>Certifications</p> <p>(TDS 210, TDS 220, TDS 224, P2100)</p> <p>(P2100)</p>	<p>CAN/CSA C22.2 No. 1010.1-92 UL3111-1, First Edition</p> <p>CAN/CSA C22.2 No. 1010.2.031 IEC61010-2-031</p>
<p>CSA Certified Power Cords</p>	<p>CSA Certification includes the products and power cords appropriate for use in the North America power network. All other power cords supplied are approved for the country of use.</p>

General Specifications (Cont.)

Certifications and Compliances

Pollution Degree 2	Do not operate in environments where conductive pollutants may be present.	
Overvoltage Category	Category:	Examples of Products in this Category:
	CAT III	Distribution-level mains, fixed installation
	CAT II	Local-level mains, appliances, portable equipment
	CAT I	Signal levels in special equipment or parts of equipment, telecommunications, electronics

Adjustment Interval

The recommended calibration interval is one year

Appendix B: Accessories

All accessories (standard and optional) are available by contacting your local Tektronix field office.

Standard Accessories



P2100 1X, 10X Passive Probes. The P2100 passive probes have a 7 MHz bandwidth with a rating of 150 V CAT II when the switch is in the 1X position, and a 100 MHz bandwidth with a rating of 300 V CAT II when the switch is in the 10X position.

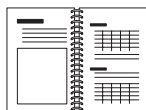

TDS 200-Series Oscilloscope User Manual. A single User Manual is included. Refer to the Optional Accessories for a complete list of available language manuals.

Optional Accessories

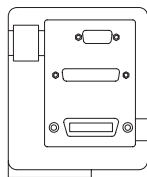

TDS2MM Measurement Extension Module. The TDS2MM module plugs directly into the rear panel of any TDS 200-Series oscilloscope. This module provides full GPIB and RS-232 compatibility and a Centronics port for hard copy output. The module allows measurement of rise time, fall time, and positive and negative pulse width. The module also provides Fast Fourier Transform (FFT).

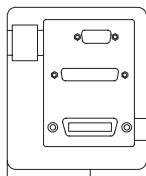

TDS2CM Communications Extension Module. The TDS2CM Communications module plugs directly into the rear panel of any TDS 200-Series oscilloscope. This module provides full GPIB and RS-232 compatibility and a Centronics port for hard copy output.

Optional Accessories (Cont.)

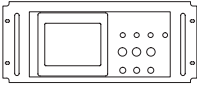

RM200 Rackmount Kit. The RM200 Rackmount Kit lets you install a TDS 200-Series oscilloscope into an industry-standard 19 inch rack. The rackmount kit requires seven inches of vertical rack space. You can turn the oscilloscope power on or off from the front of the rackmount kit. The rackmount kit does not have slide-out capability.

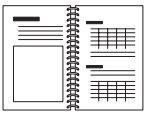

TDS 200-Series Digital Oscilloscope Service Manual. The service manual (071-0492-XX, English) provides module level repair information.

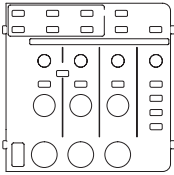

TDS 210 & TDS 220

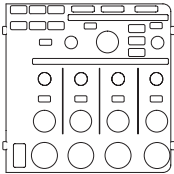

TDS 224

TDS 200-Series Digital Oscilloscope User Manuals. The User manual is available in these languages:

English	071-0398-XX
French	071-0400-XX*
Italian	071-0401-XX*
German	071-0402-XX*
Spanish	071-0399-XX*
Japanese	071-0405-XX*
Portuguese	071-0403-XX*
Simplified Chinese	071-0406-XX*
Traditional Chinese	071-0407-XX*
Korean	071-0408-XX*
Russian	071-0404-XX

*These manuals contain a language overlay for the front-panel controls.

Optional Accessories (Cont.)

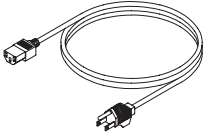

International Power Cords. In addition to the power cord shipped with your instrument, you can obtain the following cords:

Option A0, North American	120 V, 60 Hz	161-0230-01
Option A1, European	230 V, 50 Hz	161-0104-06
Option A2, United Kingdom	230 V, 50 Hz	161-0104-07
Option A3, Australian	240 V, 50 Hz	161-0104-05
Option A4, North American	240 V, 60 Hz	161-0104-08
Option A5, Switzerland	230 V, 50 Hz	161-0167-00
Option AC, China	220 V, 50 Hz	161-0304-00

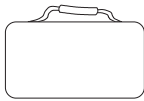

Soft Case. The soft case (AC220) protects the instrument from damage and provides space for probes, power cord, and manuals.

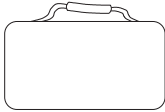

Transit Case. The transit case (HCTDS32) provides shock, vibration, impact and moisture protection for the instrument when you transport it from one place to another. The required soft case fits inside the transit case.

Appendix C: General Care and Cleaning

General Care

Do not store or leave the instrument where the LCD display will be exposed to direct sunlight for long periods of time.



CAUTION. To avoid damage to the instrument or probes, do not expose them to sprays, liquids, or solvents.

Cleaning

Inspect the instrument and probes as often as operating conditions require. To clean the exterior surface, perform the following steps:

1. Remove loose dust on the outside of the instrument and probes with a lint-free cloth. Use care to avoid scratching the clear plastic display filter.
2. Use a soft cloth dampened with water to clean the instrument. Use an aqueous solution of 75% isopropyl alcohol for more efficient cleaning.



CAUTION. To avoid damage to the surface of the instrument or probes, do not use any abrasive or chemical cleaning agents.

Glossary

AC Coupling

A mode that blocks the DC component of a signal but passes the dynamic (AC) component of the signal. Useful for observing an AC signal that is normally riding on a DC signal.

Acquisition

The process of sampling signals from input channels, digitizing the samples, processing the results into data points, and assembling the data points into a waveform record. The waveform record is stored in memory.

Aliasing

A false representation of a signal due to insufficient sampling of high frequencies or fast transitions. A condition that occurs when an oscilloscope digitizes at an effective sampling rate that is too slow to reproduce the input signal. The waveform displayed on the oscilloscope may have a lower frequency than the actual input signal.

Attenuation

The degree the amplitude of a signal is reduced when it passes through an attenuating device such as a probe or attenuator (the ratio of the input measure to the output measure). For example, a 10X probe attenuates, or reduces, the input voltage of a signal by a factor of 10.

Auto Trigger Mode

A trigger mode that causes the oscilloscope to automatically acquire if it does not detect a trigger event.

Average Acquisition Mode

A mode in which the oscilloscope acquires and displays a waveform that is the averaged result of several acquisitions. This reduces the apparent noise. The oscilloscope acquires data as in the sample mode and then averages it according to a specified number of averages.

Backlight

The illumination behind the liquid-crystal display.

Bezel Buttons

The column of buttons beside the display that select items in the menus.

Centronics

A serial communication port used to connect to a hard-copy device, computer, controller, or terminal.

Cursors

Paired markers that you can use to make measurements between two waveform locations. The oscilloscope displays the values (expressed in volts or time) of the position of each cursor and the distance between the two cursors.

DC Coupling

A mode that passes both AC and DC signal components to the circuit. Available for both the trigger system and the vertical system.

Digitizing

The process of converting a continuous analog signal such as a waveform to a set of discrete numbers representing the amplitude of the signal at specific points in time.

Display

The word used to refer to the screen or the LCD (liquid crystal display).

Edge Trigger

Triggering that occurs when the oscilloscope detects the source passing through a specified voltage level in a specified direction (the trigger slope).

GPIB

A serial communication port used to connect to a hard-copy device, computer, controller, or terminal.

Ground (GND) Coupling

Coupling option that disconnects the input signal from the vertical system.

Ground Lead

The reference lead for an oscilloscope.

Hard Copy

An electronic copy of the display in a format useable by a printer.

Holdoff

A specified amount of time that must elapse after a trigger event before the trigger circuit will accept another trigger event. Holdoff helps ensure a stable display.

Voltage Cursors

The two horizontal bars that you position to measure the voltage parameters of a waveform. The oscilloscope displays the value of each cursor with respect to ground and the voltage value between the bars.

Menu

A set of labels shown in the display to identify the functions of the bezel buttons. The specific menu contents depend on the menu button you press.

Normal Trigger Mode

A mode where the oscilloscope does not acquire a waveform record unless a valid trigger event occurs. It waits for a valid trigger event before acquiring waveform data.

Peak Detect Mode

A mode in which the oscilloscope creates a pair of record points during each sample interval. Each pair consists of the maximum and minimum input voltage during the interval.

Persistence

A method of retaining old data on the display for a period of time.

Pixel

A visible point on the display. The display is 320 pixels wide by 240 pixels high.

Pretrigger

The portion of the waveform record that contains data acquired before the trigger event.

Real-Time Digitizing

A digitizing technique that samples the input signal with a sample frequency of at least four times the oscilloscope bandwidth. (TDS 200-series oscilloscopes sample at 10 times the bandwidth or more.) Combined with $(\sin x)/x$ interpolation, all frequency components of the input up to the bandwidth are accurately displayed.

Record Length

The number of samples in a waveform.

Reference Waveform

A saved waveform selected for display.

RS-232

A serial communication port used to connect to a hard-copy device, computer, controller, or terminal.

Sample Acquisition Mode

A mode in which the oscilloscope creates a record point by saving a sample during each acquisition interval.

Sample Interval

The time interval between successive samples in a waveform record. Changing the SEC/DIV control (the time base) changes the sample interval. For real-time digitizers, the sample interval is the reciprocal of the sample rate.

Sampling

The process of capturing an analog input, such as a voltage, at a discrete point in time and holding it constant so that it can be quantized.

Scan Mode

An acquisition mode useful at slow horizontal scale settings. Scan mode allows you to view the waveform as it is acquired point-by-point. The waveform appears from left to right across the display.

Time Base

The period of time that corresponds to one horizontal division on the screen (one tenth of the waveform record) set with the SEC/DIV control. See also Sample Interval.

Time Cursors

The two vertical bars you position to measure the time parameter of a waveform record. The oscilloscope displays the value of each cursor with respect to trigger and the time value between the bars, expressed in seconds and in the reciprocal of seconds (Hertz).

Video Trigger

Triggering on the sync pulse of a composite video signal.

XY Format

A display format that compares the voltage level of two waveform records point by point. It is useful for studying phase relationships between two waveforms.

YT Format

The conventional oscilloscope display format. It shows the voltage of a waveform record (on the vertical axis) as it varies over time (on the horizontal axis).

Index

A

- AC line, trigger source, 11, 84
- accessories, 103–106
- acquire, menu, 66
- ACQUIRE button, 34, 66
- acquiring data, basic concepts, 15
- acquisition
 - live display, 69
 - modes, 15, 66
 - Average, 16
 - Peak Detect, 16
 - Sample, 15
 - single shot, 49
 - stopping, 69
- aliasing, 18
- applications
 - analyzing a differential communication signal, 60
 - analyzing signal detail, 47
 - automatic measurements, 38
 - autoset, using, 38
 - averaging, using, 48
 - calculating amplifier gain, 41
 - capturing a single-shot signal, 49
 - cursors, using, 42
 - looking at a noisy signal, 47
 - measuring propagation delay, 51
 - measuring pulse width, 42
 - measuring ring amplitude, 46
 - measuring ring frequency, 45
 - measuring rise time, 43
 - measuring two signals, 40
 - optimizing the acquisition, 50
 - peak detect, using, 47
 - reducing noise, 48

- taking automatic measurements, 39
- taking cursor measurements, 42
- triggering on a video signal, 53
- triggering on odd or even video fields, 57
- triggering on video fields, 54
- triggering on video lines, 54
- using persistence, 64
- using the math functions, 61
- using the window function, 55
- using xy mode, 64
- viewing impedance changes in a network, 63

- attenuation, probe, 89
- auto trigger, 12, 84
- automated measurements, 21
- AUTOSET, 22
 - actions, 70
 - button, 34, 70
- average, 16, 66, 69

B

- bandwidth, limit, 89
- basic concepts, 9
- broken waveforms, 28
- buttons, trigger view, 33

C

- calibration, 87
- Centronics, 2, 103
- CH 1
 - connector, 35

- MENU button, 30
- CH 2
 - connector, 35
 - MENU button, 30
- CH 3
 - connector, 35
 - MENU button, 30
- CH 4
 - connector, 35
 - MENU button, 30
- channel, scale, 26
- cleaning, 107
- coarse resolution, 89
- compensation
 - probe, 6, 35
 - signal path, 88
- connectors, 35
 - CH 1, 35
 - CH 2, 35
 - CH 3, 35
 - CH 4, 35
 - EXT TRIG, 35
 - PROBE COMP, 35
- contrast, 72
- coupling
 - trigger, 14, 83, 85
 - vertical, 89, 90
- cursor
 - adjusting, 34
 - menu, 71
 - using, 71
- CURSOR button, 34, 71
- cursors, 21
 - application example, 42
 - measurements, 42
 - time, 21
 - voltage, 21

D

- description, general, 1

- display, 24
 - contrast, 72
 - format, 72
 - indicators, 24
 - intensity, 72
 - menu, 72
 - persistence, 72
 - type, 72
- DISPLAY button, 34, 72
- dots, 72
- dual time base, 32, 74

E

- error log, 87
- EXT, trigger source, 11
- EXT TRIG connector, 35
- EXT/5, trigger source, 11
- extension, module, 2, 103
- external trigger, 35

F

- factory setup, recalling, 81
- features, overview, 1
- fine resolution, 89
- FORCE TRIGGER button, 33
- format, 72
- functional check, 5

G

- GPIB, 2, 103
- graticule, 20, 72
- gray waveforms, 28
- ground
 - marker, 26
 - probe terminal, 7
 - terminals, 35

H

HARDCOPY button, 34, 90
holdoff, 13, 32, 75
HOLDOFF control, 13, 32
horizontal
 aliasing, 18
 menu, 74
 position, 17
 position marker, 25
 scale, 17
 status, 88
HORIZONTAL MENU button, 31

I

intensity, 72
invert, 77

L

languages, 87
LEVEL, control, 32
level, 15

M

main time base, 32, 74
manuals, 104
math
 functions, 76
 menu, 76
MATH MENU button, 30
measure, menu, 79
MEASURE button, 34
measurements
 automatic, 21, 79
 basic concepts, 20
 cursor, 21, 42
 frequency, 80

 graticule, 20
 mean, 80
 peak-to-peak, 80
 period, 80
 RMS, 80
 types, 80
menu boxes
 Action Button, 27
 Circular List, 26
 Page Selection, 27
 Radio Button, 27
menu system
 menu boxes, 26
 using, 26
menus
 acquire, 66
 cursor, 71
 display, 72
 horizontal, 74
 math, 76
 measure, 79
 save/recall, 81
 trigger, 83
 utility, 87
 vertical, 89
messages, 26

N

normal operation, recall factory
 setup (default), 22
normal trigger, 84
NTSC, 57, 86

P

PAL, 54, 86
peak detect, 66, 67
persistence, 72, 73
ports, 2

- position, vertical, 89
- POSITION control
 - horizontal, 31
 - vertical, 30
- positioning waveforms, basic
 - concepts, 16
- power, 3
- power cords, 3, 105
- pretrigger view, 85
- printing, 90
- PROBE COMP connector, 35
- probes
 - attenuation, 89
 - compensation, 6, 35
 - safety, 7
 - specifications, 101
- R**
- recalling
 - factory setup (default), 22
 - setups, 22
 - waveforms, 82
- resolution, fine, 90
- roll mode. *See scan mode*
- RS-232, 2, 103
 - hard copy, 90
- RUN/STOP button, 34
- S**
- sample, 66, 67
- sample rate, maximum, 67
- SAVE/RECALL button, 34, 81
- saving
 - setups, 22, 81
 - waveforms, 82
- scaling waveforms, basic concepts, 16
- scan mode, 69, 75
- scanning waveform, 69, 75, 84
- SEC/DIV control, 32, 75
- SECAM, 86
- security, 3
- self cal, 87
- service, 87, 104
- SET LEVEL TO 50% button, 33
- setups
 - basic concepts, 21
 - saving and recalling, 81
- signal path compensation, 88
- single acquisition, 84
- single shot, application example, 49
- slope, 14
- source, trigger, 10, 83, 86
- specifications, 91
- status, system, 87
- sync pulse, 86
- T**
- time base, 26
 - main, 32, 74
 - window, 32, 74
- time cursors, 21, 71
- trigger
 - coupling, 14, 83, 85
 - edge, 11, 83
 - external, 86
 - field, 86
 - holdoff, 13, 32, 75
 - level, 15, 32, 75, 83
 - marker, 25
 - readout, 25
 - menu, 83
 - modes, 11
 - Auto, 12, 84
 - Normal, 12, 84
 - Single, 12, 84

position, 14
position marker, 25
slope, 14, 83
source, 10, 83
status, 25, 88
sync, 86
types, 11
video, 86
view, 33, 85, 86
TRIGGER MENU button, 33
trigger position, readout, 25
trigger slope, indicator, 25
trigger source, 10, 26
TRIGGER VIEW button, 33, 85
triggering, basic concepts, 10

U

utility, menu, 87
UTILITY button, 34

V

vectors, 72
vertical
 menu, 89
 position, 17
 scale, 17
 status, 88
video trigger, application example,
 53
voltage cursors, 21, 71

volts/div
 coarse, 89
 fine, 89
 math, 78
VOLTS/DIV control, 30

W

waveform
 See also applications
 acquiring data, 15
 appearance, 28
 compression, 75
 displays, 28
 expansion, 75
 off, 90
 saving and recalling, 81
 taking measurements, 20
window time base, 32, 74
window zone, 26, 75

X

XY, 72
 application example, 64
 display, 73

Y

YT, 72

